

Alicates amperímetros digitais

AAV 1001
38.70.001.001
Inteligente AAV 6002I
38.70.600.200



Alicates desencapadores de fios

36.86.000.006 - 6" - 152 mm
36.86.000.008 - 8" - 203 mm



Alicate para freios de tambor, 300 mm

65.10.300.000



Base para a bomba de pulverização agrícola

66.86.830.300

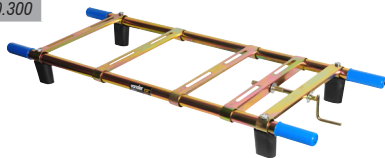

Arames MIG, barrica com 250 kg

74.44.010.250 - 1,0 mm
74.44.012.250 - 1,2 mm



Paleta hidráulica em aço inox parcial, 2,5 tf, 1.150 mm x 685 mm, PIN 258

68.89.258.068



Acessórios para Lavadora e Aspirador LAV 1412

Bico Reto Bico médio triangular
68.98.094.141 68.98.093.141
Bico chato Adaptador posição 62
68.98.096.141 68.98.062.141
Bico escova
68.98.077.141



Carreta agrícola 300 kgf

68.03.300.000



Carrinho para carga, dobrável, com bolsa, 60 kgf

61.60.000.060



Carrinho para carga 2 em 1, 300 kgf

61.60.210.300



Botas de PVC, cano médio

Branças - Com forro	Pretas - Com forro
70.69.360.000 - tamanho 36	70.59.360.000 - tamanho 36
70.69.370.000 - tamanho 37	70.59.370.000 - tamanho 37
70.69.380.000 - tamanho 38	70.59.380.000 - tamanho 38
70.69.390.000 - tamanho 39	70.59.390.000 - tamanho 39
70.69.400.000 - tamanho 40	70.59.400.000 - tamanho 40
70.69.410.000 - tamanho 41	70.59.410.000 - tamanho 41
70.69.420.000 - tamanho 42	70.59.420.000 - tamanho 42
70.69.430.000 - tamanho 43	70.59.430.000 - tamanho 43
70.69.444.500 - tamanho 44/45	70.59.444.500 - tamanho 44/45

Branças - Sem forro	Pretas - Sem forro
70.67.360.000 - tamanho 36	70.58.360.000 - tamanho 36
70.67.370.000 - tamanho 37	70.58.370.000 - tamanho 37
70.67.380.000 - tamanho 38	70.58.380.000 - tamanho 38
70.67.390.000 - tamanho 39	70.58.390.000 - tamanho 39
70.67.400.000 - tamanho 40	70.58.400.000 - tamanho 40
70.67.410.000 - tamanho 41	70.58.410.000 - tamanho 41
70.67.420.000 - tamanho 42	70.58.420.000 - tamanho 42
70.67.430.000 - tamanho 43	70.58.430.000 - tamanho 43
70.67.444.500 - tamanho 44/45	70.58.444.500 - tamanho 44/45



Botas de PVC pretas com solado amarelo, cano médio, com forro

70.79.360.000 - tamanho 36	70.79.410.000 - tamanho 41
70.79.370.000 - tamanho 37	70.79.420.000 - tamanho 42
70.79.380.000 - tamanho 38	70.79.430.000 - tamanho 43
70.79.390.000 - tamanho 39	70.79.444.500 - tamanho 44/45
70.79.400.000 - tamanho 40	



Carregadores inteligentes de bateria

CIB 330

68.47.330.000 - 127 V~ - 220 V~

CIB 222 - com conector

68.47.200.222 - 220 V~ - 240 V~



Maçaricos e acessórios

Maçarico para gás MAPP, jogo com 3 pontas

74.42.003.000

Maçarico portátil, gás butano

74.42.200.000

Conjunto para solda plástica, para maçarico 3 em 1

74.42.033.000



Jogo de chaves fenda/phillips/hexalobular com 18 peças

30.72.218.000



Jogo de brocas de aço rápido DIN 338, 1,0 mm a 10,0 mm, com 19 peças

53.53.019.110



Jogo de bits, brocas e soquetes com 35 peças

53.53.035.000



Jogo de brocas combinadas com 9 peças, aço rápido/vidoa/madeira

53.53.009.568



Chave para sonda lambda, 22 mm

65.10.022.120



Chave para junta do braço axial da caixa de direção

65.10.274.212



Cintas de lixa 100 mm x 610 mm, embalagem com 10 peças

12.37.120.120 - G 120

12.37.120.100 - G 100

12.37.120.080 - G 080

12.37.120.060 - G 060



Cinto completo para roçadeiras a gasolina

68.05.200.000



Rodas para Máquinas de Cortar Grama VONDER

MGV 1001

68.99.001.122

MGV 162

68.99.016.043 - 7"

68.99.016.059 - 8"



Máquina a gasolina para cortar grama, 16", 2 hp, MGV 162

68.18.016.020



Lâminas para Máquinas de Cortar Grama VONDER

16" para MGV 162

68.99.016.037

MGV 1001

68.99.001.127



Esquadro articulado, 6 seções

35.50.012.006

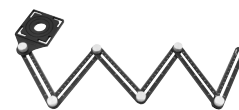

Estilete de Segurança

35.99.009.002



Extrator de braço pitman, 1,5/16"

65.10.033.063



Extrator universal para articulação esférica

65.10.020.050



Fecho para móveis, rolete, com parafuso autoatarraxante, 3,5 X 13

32.90.000.020



Filtro HEPA para Lavadora e Aspirador LAV 1412 VONDER

68.98.016.141



Fixador de porta FP 555, arruela inox

35.99.100.555



Grampos de aperto rápido

35.80.100.225 - Horizontal GHV 225	35.80.400.385 - Torpedo GTPV 385
35.80.500.880 - Tipo tensor GTV 880	35.80.400.680 - Torpedo GTPV 680
35.80.300.300 - Torpedo GTPV 300	35.80.200.220 - Vertical GVV 220



Lâminas circulares multicorte

46.75.185.048 - 185 mm x 48 dentes
46.75.355.080 - 355 mm x 80 dentes

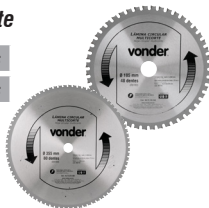

Lâminas para serra sabre

46.99.153.013 - madeira
46.99.150.013 - metal



Lâmina de serra tico-tico VD 101AOF-UN

46.33.204.101



Lâmina para Estilete de Segurança VONDER

35.99.009.010



Limas manuais para funileiro

43.91.014.010 - 1/4" x 10"
43.91.014.012 - 1/4" x 12"



Motosserra a gasolina, 35,8 cm³ (cc), MGV 358

68.84.358.000



Lonas plásticas cortadas, amarelas, grossas

61.18.010.402 - 4 m x 2 m
61.18.010.404 - 4 m x 4 m
61.18.010.406 - 4 m x 6 m
61.18.010.408 - 4 m x 8 m



Refrigerador automotivo 12 V, 20 litros

33.11.020.000



Politrizes angulares

5", PAV 600

60.01.600.127 - 127 V~
60.01.600.230 - 220 V~

7", PAV 1300

60.01.130.127 - 127 V~
60.01.130.230 - 220 V~



Sabre de 12" - 30,4 cm, calibre 0,050", com corrente

68.42.120.050



Cortador de chapas CC 050

36.24.100.000



Chumbadores com parafusos

28.48.142.000 - 1/4" x 2"	28.48.388.000 - 3/8" x 80 mm
28.48.143.000 - 1/4" x 3"	28.48.516.214 - 5/16" x 2.1/4"
28.48.146.500 - 1/4" x 65 mm	28.48.516.750 - 5/16" x 75 mm
28.48.382.120 - 3/8" x 2.1/2"	



Escâpulas

Com buchas plásticas com anel

28.94.134.600 - 3,3 mm x 42 mm	28.94.249.700 - 10,0 mm
28.94.144.700 - 4,4 mm x 55 mm	28.94.244.700 - 8,0 mm
28.94.149.700 - 4,8 mm x 60 mm	28.94.234.600 - 6,0 mm



Parafusos madeira

20.21.423.000 - 4,2 mm x 30 mm
20.21.424.000 - 4,2 mm x 40 mm



Parafusos madeira chipboard, cabeça chata phillips

20.22.140.220 - 4 mm x 22 mm
20.22.140.300 - 4 mm x 30 mm
20.22.140.500 - 4 mm x 50 mm

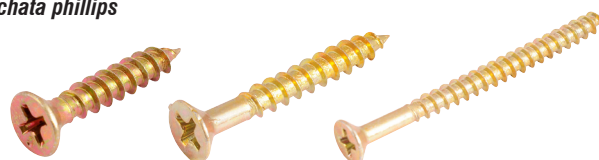

Parafusos para drywall

Ponta brocante

20.99.421.300 - 4,2 mm x 13 mm

Ponta agulha

20.99.142.130 - 4,2 mm x 13 mm

20.99.353.500 - 3,5 mm x 35 mm



Parafuso sextavado rosca soberba 1/4" x 70 mm

20.87.114.700



Parafusos sextavados zincados

UNC

20.63.014.100 - 1/4" x 1"

20.63.014.112 - 1/4" x 1.1/2"

20.63.014.200 - 1/4" x 2"

20.63.014.212 - 1/4" x 2.1/2"

20.63.014.780 - 1/4" x 7/8"

20.63.038.100 - 3/8" x 1"

20.63.381.120 - 3/8" x 1.1/2"

20.63.516.100 - 5/16" x 1"

20.63.516.112 - 5/16" x 1.1/2"

20.63.516.200 - 5/16" x 2"

BSW

20.63.316.340 - 3/16" x 3/4"



Parafusos francês zincados, com porcas e arruelas

20.44.142.000 - 1/4" x 2"

20.44.383.000 - 3/8" x 3"

20.44.142.120 - 1/4" x 2.1/2"

20.44.516.200 - 5/16" x 2"

20.44.143.000 - 1/4" x 3"

20.44.516.212 - 5/16" x 2.1/2"

20.44.316.200 - 3/16" x 2"

20.44.516.300 - 5/16" x 3"

20.44.382.120 - 3/8" x 2.1/2"



Parafusos máquina cabeça redonda, com porcas e arruelas lisas

20.36.316.200 - 3/16" x 2"

Inox

20.36.316.340 - 3/16" x 3/4"

20.40.142.000 - 1/4" x 2"

20.36.532.100 - 5/32" x 1"

20.40.316.100 - 3/16" x 1"

20.36.532.120 - 5/32" x 1/2"

20.40.316.120 - 3/16" x 1/2"

20.36.532.580 - 5/32" x 5/8"

20.40.316.340 - 3/16" x 3/4"



Percevejo latonado

20.88.000.011



Parafusos autoatarraxantes

Cabeça chata, phillips

20.06.004.216 - 4,2 mm x 16,0 mm

20.06.004.232 - 4,2 mm x 32,0 mm

20.06.004.238 - 4,2 mm x 38,0 mm

20.03.423.200 - 4,2 mm x 32,0 mm - inox

20.06.135.190 - 3,5 mm x 19,0 mm - com bucha 5 mm

20.06.142.320 - 4,2 mm x 32,0 mm - com bucha 7 mm

20.06.142.380 - 4,2 mm x 38,0 mm - com bucha 7 mm

Cabeça panela

20.07.423.800 - 4,2 mm x 38,0 mm

20.07.483.800 - 4,8 mm x 38,0 mm

20.08.004.232 - 4,2 mm x 32,0 mm - phillips

20.08.004.238 - 4,2 mm x 38,0 mm - phillips

20.08.420.160 - 4,2 mm x 16,0 mm - phillips



Piões

28.94.334.600 - 3,3 mm x 53 mm

28.94.434.600 - 3,3 mm x 53 mm - com bucha plástica de 6 mm com anel

28.94.344.700 - 4,4 mm x 67 mm

28.94.444.700 - 4,4 mm x 67 mm - com bucha plástica de 8 mm com anel

28.94.349.700 - 4,8 mm x 67 mm

28.94.449.700 - 4,8 mm x 67 mm - com bucha plástica de 10 mm com anel



Porcas sextavadas

Inox

28.62.140.000 - 1/4"

28.62.316.000 - 3/16"

28.62.380.000 - 3/8"

28.62.516.000 - 5/16"

28.62.532.000 - 5/32"

Zincada

28.52.140.000 - 1/4"

28.52.316.000 - 3/16"

28.52.380.000 - 3/8"

28.52.516.000 - 5/16"



Porcas borboleta zincadas

28.55.140.000 - 1/4"

28.55.316.000 - 3/16"

28.55.532.000 - 5/32"



Refil para Varredeira Manual de Piso VONDER

93.68.320.320



Buchas de fixação

Com anel

28.94.112.000 - 12 mm

28.94.110.000 - 10 mm

28.94.108.000 - 8 mm

28.94.106.000 - 6 mm

28.94.105.000 - 5 mm

Cartela com 10

28.94.008.000 - 8 mm

Para drywall

28.94.310.000 - 10 mm

28.94.308.000 - 8 mm

28.94.306.000 - 6 mm



Tachinhas

20.88.000.008 - nº 8

20.88.000.010 - nº 10



Arruela de pressão 5/16"

28.12.000.516



Arruelas lisas

Zincada

28.16.000.014 - 1/4"

28.16.000.516 - 5/16"

Inox

28.22.000.014 - 1/4"



Ganchos

28.95.144.700 - 4,4 mm x 67 mm

Com bucha plástica com anel

28.95.249.700 - 10,0 mm

28.95.244.700 - 8,0 mm



Tubo posição 90 para Lavadora e Aspirador LAV 1412 VONDER

68.98.090.141



Vedantes para torneira

- 80.60.000.120 - PVC 1/2"
- 80.60.000.340 - PVC 3/4"
- 80.60.000.012 - Borracha 1/2"
- 80.60.000.034 - Borracha 3/4"



nove54

ferramentas

MULTIMARCAS

Regulador de pressão AIR FIL 1 CDDA - ARPRESX

62.14.001.001



Maçarico portátil, gás butano

74.42.300.000



Cinto de segurança paraquedista Evolution 3I - CARBOGRAFITE

70.19.000.003



Soquetes sextavados de impacto - GEDORE RED

- 30.41.300.535 - encaixe de 1/2" - 22 mm
- 30.41.300.531 - encaixe de 1/2" - 16 mm



Brocas para concreto

- 53.51.000.030 - 3,0 mm - 1/8"
- 53.51.000.040 - 4,0 mm - 5/32"
- 53.51.000.050 - 5,0 mm - 3/16"
- 53.51.000.060 - 6,0 mm - 15/64"
- 53.51.000.070 - 7,0 mm - 9/32"
- 53.51.000.080 - 8,0 mm - 5/16"
- 53.51.000.100 - 10,0 mm - 13/32"
- 53.51.000.120 - 12,0 mm - 15/32"



Chaves estrela - GEDORE RED

- 30.61.060.700 - 6 mm x 7 mm
- 30.61.080.900 - 8 mm x 9 mm
- 30.61.252.800 - 25 mm x 28 mm
- 30.68.129.160 - 1/2" x 9/16"
- 30.68.387.160 - 3/8" x 7/16"
- 30.61.171.900 - 17 mm x 19 mm - R01181719



Chaves combinadas - GEDORE RED

- 30.64.011.160 - 1.1/16"
- 30.64.114.000 - 1.1/4"
- 30.64.140.000 - 1/4"
- 30.64.151.600 - 15/16"
- 30.64.516.000 - 5/16"



Chaves fixas - GEDORE RED

- 30.82.080.900 - 8 mm x 9 mm
- 30.82.141.500 - 14 mm x 15 mm
- 30.82.212.300 - 21 mm x 23 mm
- 30.82.242.600 - 24 mm x 26 mm
- 30.82.242.700 - 24 mm x 27 mm
- 30.82.252.800 - 25 mm x 28 mm
- 30.82.273.200 - 27 mm x 32 mm
- 30.84.387.160 - 3/8" x 7/16"
- 30.84.581.116 - 5/8" x 11/16"



Disco de fibra Strip Disc, 115,0 mm x 22 mm, preto NORTON

12.82.412.782



Disco de corte para madeira 110 mm 69957315170 - NORTON

12.67.315.170



Motor elétrico aberto, alto rendimento, 1 cv, 4 polos, IR3 trifásico, 220 V~/380 V~ NOVA MOTORES

66.80.421.010



Pilha D grande 10210 - RAYOVAC

80.55.010.210



Nível de alumínio trapezoidal 12", com base magnética, KLTS12 - STARRETT

33.35.031.112



Motor elétrico blindado, alto rendimento, 5 cv, 4 polos, IR3 trifásico, 220 V~/380 V~ NOVA MOTORES

66.80.480.050



Botas de PVC brancas, com forro, cano longo - MARLUVAS

- 70.04.000.036 - tamanho 36
- 70.04.000.037 - tamanho 37
- 70.04.000.038 - tamanho 38
- 70.04.000.039 - tamanho 39
- 70.04.000.040 - tamanho 40
- 70.04.000.041 - tamanho 41
- 70.04.000.042 - tamanho 42
- 70.04.000.043 - tamanho 43
- 70.04.000.044 - tamanho 44
- 70.04.000.045 - tamanho 45



Consolidado mensal de lançamentos

Janeiro 2020

MULTIMARCAS

Botas de PVC brancas, cano médio, Vulcaflex - MARLUVAS

Sem forro

70.05.100.036 - tamanho 36	70.05.100.041 - tamanho 41
70.05.100.037 - tamanho 37	70.05.100.042 - tamanho 42
70.05.100.038 - tamanho 38	70.05.100.043 - tamanho 43
70.05.100.039 - tamanho 39	70.05.100.044 - tamanho 44
70.05.100.040 - tamanho 40	70.05.100.045 - tamanho 45

Com forro

70.05.000.360 - tamanho 36	70.05.000.410 - tamanho 41
70.05.000.370 - tamanho 37	70.05.000.420 - tamanho 42
70.05.000.380 - tamanho 38	70.05.000.430 - tamanho 43
70.05.000.390 - tamanho 39	70.05.000.440 - tamanho 44
70.05.000.400 - tamanho 40	70.05.000.450 - tamanho 45



Botas de PVC pretas, cano médio, Vulcaflex - MARLUVAS

Sem forro

70.05.000.136 - tamanho 36	70.05.000.036 - tamanho 36
70.05.000.137 - tamanho 37	70.05.000.037 - tamanho 37
70.05.000.138 - tamanho 38	70.05.000.038 - tamanho 38
70.05.000.139 - tamanho 39	70.05.000.039 - tamanho 39
70.05.000.140 - tamanho 40	70.05.000.040 - tamanho 40
70.05.000.141 - tamanho 41	70.05.000.041 - tamanho 41
70.05.000.142 - tamanho 42	70.05.000.042 - tamanho 42
70.05.000.143 - tamanho 43	70.05.000.043 - tamanho 43
70.05.000.144 - tamanho 44	70.05.000.044 - tamanho 44
70.05.000.145 - tamanho 45	70.05.000.045 - tamanho 45

Com forro



Botas de PVC pretas, com forro, cano longo - MARLUVAS

70.04.000.360 - tamanho 36
70.04.000.370 - tamanho 37
70.04.000.380 - tamanho 38
70.04.000.390 - tamanho 39
70.04.000.400 - tamanho 40
70.04.000.410 - tamanho 41
70.04.000.420 - tamanho 42
70.04.000.430 - tamanho 43
70.04.000.440 - tamanho 44
70.04.000.450 - tamanho 45



Para mais informações acesse nosso site: www.dismatal.com.br

Roçadeiras a gasolina

- 68.04.100.427 - 42,7 cm³ (cc) RGO 427
- 68.04.200.254 - 25,4 cm³ (cc) RGO 2540C
- 68.04.100.254 - 25,4 cm³ (cc) RGO 254
- 68.04.100.326 - 32,6 cm³ (cc) RGO 326
- 68.04.100.517 - 51,7 cm³ (cc) RGO 517



Serras mármore SMV 1450 sem disco

- 60.01.145.110 - 127 V~
- 60.01.145.230 - 220 V~



Escadas telescópicas de alumínio, 8 degraus

- 85.01.000.080
- Com amortecedor
- 85.01.000.008



Mesas hidráulicas pantográficas, duplo estágio

- 68.89.302.000 - 0,35 tonelada (0,35 tf) MPP 352
- 68.89.152.000 - 0,15 tonelada (0,15 tf) MPP 152



Parafusadeira/furadeira a bateria, 12 V, carregador bivolt automático, PFV 112QR

- 60.01.112.000



Alicate crimpador para terminal solar MC 4

- 36.86.004.000



Grampos de aperto rápido

- Tipo tensor
- 35.80.500.150 - GTV 150
- 35.80.500.300 - GTV 300
- Torpedo
- 35.80.300.130 - GTPV 130
- 35.80.400.225 - GTPV 225
- 35.80.300.090 - GTPV 90
- Vertical
- 35.80.200.100 - GVV 100



Alicate para anéis, jogo com 4 peças, 6 1/2" 165 mm e 7" - 178 mm

- 36.62.004.007



Alicates para anéis

- Externos
- 36.62.290.000 - bico curvo, 11.1/2" - 292 mm
- 36.62.310.000 - bico reto, 12" - 305 mm
- Interno
- 36.62.000.310 - bico reto, 12" - 305 mm



Testador de baterias TBV 1200

- 68.45.120.000



Bateria ions de lítio, 48 V - 20 Ah, para carro hidráulico CSE 150

- 68.79.150.330



Lanternas recarregáveis

- LR 180I
- 80.75.015.180 - 2 W COB + 3 LEDs
- LR 300I
- 80.75.030.300 - 3 W COB + 6 LEDs



Lanternas recarregáveis para cabeça

- LED COB
- 80.75.003.300 - LCV 30
- LED
- 80.75.001.100 - LRV 100



Lanterna recarregável pendente, 10 W COB, LR 1000

- 80.75.101.000



Lanterna recarregável para bicicleta

- 80.75.150.280



Lanterna recarregável articulada, LED COB, LR 500

80.75.250.500



Lanternas recarregáveis de inspeção

5 W LED CRI 96, bivolt LCV 300

80.75.096.005

7 W COB + 3 W CREE, LR 700

80.75.150.700

Ultrafina articulada, LR 600

80.75.120.600

Compacta, LED SMD, LR 300

80.75.100.300



Refletor recarregável, LED SMD 10 W, RRV 010

80.75.010.900



Mangueira para óleo e graxa 5/16" - 7,94 mm, PT 350 lbf/pol², PVC

80.77.000.516



Bastão magnético, 390 mm

35.99.390.000



Pistola para pintura, com caneca plástica, ar direto, PPV 90

62.20.900.000



Mandris de aperto rápido de precisão

66.70.110.012 - 1 mm - 10 mm B12

66.70.113.016 - 1 mm - 13 mm B16

66.70.116.018 - 1 mm - 16 mm B18

66.70.520.022 - 5 mm - 20 mm B22



Filmes stretch

Sem tubete

11.32.050.030 - 500 mm x 260 m, 25 micra - aprox. 3 quilos

Com tubete

11.32.050.004 - 500 mm x 228 m, 25 micra - aprox. 4 quilos

11.32.050.003 - 500 mm x 260 m, 25 micra - aprox. 3,5 quilos

11.32.050.012 - 500 mm x 870 m, 25 micra - aprox. 12 quilos

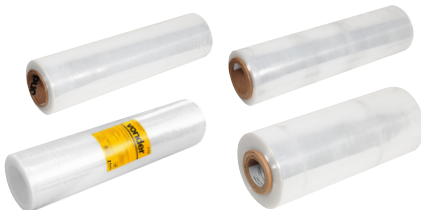

Tubete para filme stretch, aplicador

11.32.000.060



Arruelas

De pressão

28.12.000.014 - 1/4"

28.12.000.316 - 3/16"

28.12.000.038 - 3/8"

Lisas

28.22.000.316 - 3/16" inox

28.22.000.038 - 3/8" inox

28.22.000.516 - 5/16" inox

28.22.000.532 - 5/32" inox

28.16.000.316 - 3/16" zincada

28.16.000.038 - 3/8" zincada



Parafusos para drywall, ponta agulha

20.99.352.500 - 3,5 mm x 25 mm

20.99.354.500 - 3,5 mm x 45 mm



Parafuso francês zincado, com porca e arruela, 3/16" x 1.1/2"

20.44.316.112



Chaves de roda tipo cruz

36.97.170.210 - 17 mm x 19 mm x 21 mm x espátula

Com adaptador para soquete

36.97.170.012 - 17 mm x 19 mm x 21 mm x 1/2"



Pontas fixas de metal duro

66.70.500.000 - CM5

66.70.400.000 - CM4

66.70.300.000 - CM3



Hastes para mandril

66.70.312.000 - CM3 - B12

66.70.418.000 - CM4 - B18

66.70.316.000 - CM3 - B16

66.70.422.000 - CM4 - B22

66.70.318.000 - CM3 - B18

66.70.516.000 - CM5 - B16

66.70.322.000 - CM3 - B22

66.70.518.000 - CM5 - B18

66.70.416.000 - CM4 - B16

66.70.522.000 - CM5 - B22



Buchas de redução

66.70.054.000 - CM5 x CM4

66.70.053.000 - CM5 x CM3

66.70.043.000 - CM4 x CM3



Pontas rotativas

66.70.000.300 - CM3 250 kgf

66.70.000.030 - CM3 400 kgf

66.70.000.400 - CM4 400 kgf

66.70.000.500 - CM5 800 kgf



Brocas com encaixe tipo SDS PLUS

53.67.100.330 - 10,0 mm x 330 mm x 400 mm

53.67.080.240 - 8,0 mm x 240 mm x 310 mm



nove54

ferramentas

Politrizes angulares 5", PAD 600

60.05.600.230 - 220 V~
60.05.600.127 - 127 V~



Lixadeiras orbitais LOD 210

60.05.210.127 - 127 V~
60.05.210.220 - 220 V~



Mangueiras de ar e água 300 lbf/pol²

80.06.954.121 - 1/2" - 12,7 mm
80.06.954.141 - 1/4" - 6,35 mm

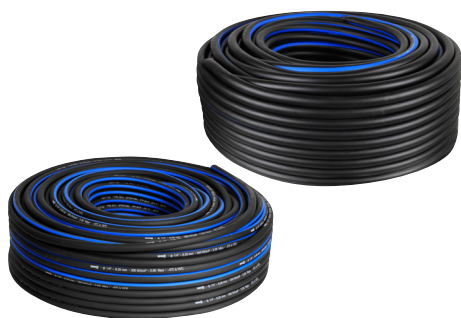

MULTIMARCAS

Chaves fixas - GEDORE RED

30.84.145.160 - 1/4" x 5/16"
30.84.583.400 - 5/8" x 3/4"



Chaves estrela - GEDORE RED

30.61.242.600 - 24 mm x 26 mm
30.61.273.200 - 27 mm x 32 mm
30.68.583.400 - 5/8" x 3/4"



Soquetes sextavados de impacto, encaixe de 1/2" GEDORE RED

30.41.300.526 - 11 mm
30.41.300.527 - 12 mm



Adesivo cola tudo, branco, 458 g - UNIFIX

16.47.180.102



Lápis para carpinteiro - LUFKIN

30.76.072.000



Difusor de gás para tocha XC443 branco - OXIMIG

74.80.443.360



Motores elétricos abertos, alto rendimento, 4 polos, IR3 trifásico, 220 V~/380 V~ NOVA MOTORES

66.80.421.020 - 2 cv
66.80.421.030 - 3 cv



Botinas nobuck velcro com solado em poliuretano bidensidade, sem biqueira, 50B26 - MARLUVAS

70.46.026.038 - nº 38
70.46.026.039 - nº 39
70.46.026.040 - nº 40
70.46.026.041 - nº 41
70.46.026.042 - nº 42
70.46.026.043 - nº 43
70.46.026.044 - nº 44
70.46.026.045 - nº 45



Botinas nobuck pretas com solado em poliuretano bidensidade, sem biqueira, 50B26 - MARLUVAS

70.46.026.380 - nº 38
70.46.026.390 - nº 39
70.46.026.400 - nº 40
70.46.026.410 - nº 41
70.46.026.420 - nº 42
70.46.026.430 - nº 43
70.46.026.440 - nº 44
70.46.026.450 - nº 45



Mandris de aperto rápido metálicos

- 66.70.310.380 - 10 mm - 3/8" - rosca 3/8"
- 66.70.313.120 - 13 mm - 1/2" - rosca 1/2"



Lâmina de corte para Plaina PDV 1500 VONDER

- 60.99.150.157



Limas abrasadeiras recurvadas para funileiro

- 43.10.010.000 - 10"
- 43.10.012.000 - 12"



Broca de aço rápido escalonada para telha de fibrocimento

- 53.44.064.011 - 6,4 mm x 11 mm x 209 mm



Buchas de redução

- 66.70.064.000 - CM6 x CM4
- 66.70.065.000 - CM6 x CM5



Extensão magnética

- 30.39.014.120 - 1/4" x 120 mm



Brocas com encaixe tipo SDS PLUS

- 53.67.160.320 - 16,0 mm x 320 mm x 400 mm
- 53.67.190.320 - 19,0 mm x 320 mm x 400 mm



Brocas para vidro

- 53.20.008.080 - 8 mm x 80 mm
- 53.20.010.100 - 10 mm x 100 mm



Pontas rotativas

- 66.70.000.003 - CM3 250 kgf
- 66.70.000.004 - CM4 350 kgf
- 66.70.000.005 - CM5 500 kgf
- 66.70.000.040 - CM4 600 kgf
- 66.70.000.050 - CM5 1.200 kgf



Jogo de ferramentas

- 35.99.040.040 - 40 peças



Jogos de bits/ponteiras, encaixe sextavado 1/4", com engate rápido

- 35.38.000.015 - 15 peças
- 35.38.000.032 - 32 peças



Jogo de fresas escariadoras para madeira

- 35.99.039.010 - 10 peças



Parafusos autoatarraxantes, cabeça chata, phillips

- 20.06.002.913 - 2,9 mm x 13,0 mm
- 20.06.002.919 - 2,9 mm x 19,0 mm
- 20.06.003.513 - 3,5 mm x 13,0 mm
- 20.06.003.516 - 3,5 mm x 16,0 mm
- 20.06.003.519 - 3,5 mm x 19,0 mm
- 20.06.003.525 - 3,5 mm x 25,0 mm
- 20.06.003.916 - 3,9 mm x 16,0 mm
- 20.06.003.925 - 3,9 mm x 25,0 mm
- 20.06.003.932 - 3,9 mm x 32,0 mm
- 20.06.004.838 - 4,8 mm x 38,0 mm
- 20.06.004.850 - 4,8 mm x 50,0 mm
- 20.06.006.350 - 6,3 mm x 50,0 mm



Parafusos autoatarraxantes inox, cabeça chata, phillips

- 20.03.393.200 - 3,9 mm x 32,0 mm
- 20.03.291.900 - 2,9 mm x 19,0 mm
- 20.03.351.900 - 3,5 mm x 19,0 mm
- 20.03.352.500 - 3,5 mm x 25,0 mm
- 20.03.392.500 - 3,9 mm x 25,0 mm
- 20.03.483.800 - 4,8 mm x 38,0 mm
- 20.03.485.000 - 4,8 mm x 50,0 mm
- 20.03.555.000 - 5,5 mm x 50,0 mm



Tachinha nº 12

- 20.88.000.012



Parafusos sextavados zincados

UNC

- 20.63.038.200 - 3/8" x 2"

BSW

- 20.63.316.100 - 3/16" x 1"
- 20.63.316.112 - 3/16" x 1.1/2"
- 20.63.316.114 - 3/16" x 1.1/4"
- 20.63.316.200 - 3/16" x 2"



Parafusos autoatarraxantes, cabeça panela, phillips

- 20.08.002.916 - 2,9 mm x 16,0 mm
- 20.08.002.919 - 2,9 mm x 19,0 mm
- 20.08.350.130 - 3,5 mm x 13,0 mm
- 20.08.350.160 - 3,5 mm x 16,0 mm
- 20.08.003.519 - 3,5 mm x 19,0 mm
- 20.08.003.525 - 3,5 mm x 25,0 mm
- 20.08.003.925 - 3,9 mm x 25,0 mm
- 20.08.003.932 - 3,9 mm x 32,0 mm
- 20.08.004.838 - 4,8 mm x 38,0 mm
- 20.08.004.850 - 4,8 mm x 50,0 mm
- 20.08.006.350 - 6,3 mm x 50,0 mm



Parafusos madeira

- 20.21.252.500 - 2,5 mm x 25 mm
- 20.21.281.600 - 2,8 mm x 16 mm
- 20.21.322.500 - 3,2 mm x 25 mm
- 20.21.353.000 - 3,5 mm x 30 mm
- 20.21.383.000 - 3,8 mm x 30 mm
- 20.21.384.000 - 3,8 mm x 40 mm
- 20.21.484.000 - 4,8 mm x 40 mm
- 20.21.485.000 - 4,8 mm x 50 mm



Buchas de fixação

Cartela com 10 peças

- 28.94.005.000 - 5 mm
- 28.94.006.000 - 6 mm
- 28.94.007.000 - 7 mm
- 28.94.010.000 - 10 mm

Cartela com 4 peças

- 28.94.012.000 - 12 mm



Parafusos autoatarraxantes, cabeça panela

- 20.07.352.500 - 3,5 mm x 25,0 mm
- 20.07.485.000 - 4,8 mm x 50,0 mm
- 20.07.635.000 - 6,3 mm x 50,0 mm
- 20.07.291.300 - 2,9 mm x 13,0 mm
- 20.07.351.900 - 3,5 mm x 19,0 mm



Parafusos autoatarraxantes, cabeça chata, phillips, com bucha

- 20.06.135.250 - 3,5 mm x 25,0 mm - bucha 5 mm
- 20.06.139.250 - 3,9 mm x 25,0 mm - bucha 6 mm
- 20.06.139.320 - 3,9 mm x 32,0 mm - bucha 6 mm
- 20.06.148.380 - 4,8 mm x 38,0 mm - bucha 8 mm
- 20.06.148.500 - 4,8 mm x 50,0 mm - bucha 8 mm
- 20.06.163.500 - 6,3 mm x 50,0 mm - bucha 10 mm



Roldanas

Arraste para máquinas MIG/MAG MM 300 e MM 400 VONDER

68.58.300.047 - 1,2 mm - 1,6 mm

68.58.300.112 - 1,0 mm - 1,2 mm - alumínio

Para máquinas MIG/MAG MM 251 e MM 305 VONDER

68.99.251.113 - 0,8 mm - 1,0 mm - alumínio

68.99.251.117 - 1,0 mm - 1,2 mm - alumínio

68.99.251.116 - 1,0 mm - 1,2 mm - aço tubular

68.99.251.114 - 0,8 mm - 0,9 mm - aço

Para máquinas MIG/MAG MM 251 VONDER

68.99.251.108 - 0,8 mm - 1,0 mm - aço

Para máquinas MIG/MAG MM 405 VONDER

68.99.405.222 - 0,8 mm - 1,0 mm - alumínio

68.99.405.223 - 1,0 mm - 1,2 mm - alumínio

68.99.405.220 - 1,0 mm - 1,2 mm - aço tubular

68.99.405.221 - 1,2 mm - 1,6 mm - aço tubular

68.99.405.216 - 1,0 mm - 1,2 mm - aço

68.99.405.219 - 1,2 mm - 1,6 mm - aço



Alicates

Anéis externos

36.62.130.000 - Bico reto - 5" - 127 mm

36.62.114.000 - Bico curvo - 4.1/2" - 114,3 mm

Anéis internos

36.62.000.130 - Bico reto, 5" - 127 mm

36.62.000.114 - Bico curvo - 4.1/2" - 114,3 mm

36.62.000.290 - Bico curvo - 11.1/2" - 292 mm

Multifunção para solda

36.62.002.100



Cortadores de tubos de PVC

35.59.420.000 - 42 mm

35.59.640.000 - 64 mm



Afiador de facas e tesouras, com vídea e cerâmica

12.40.100.400



Testador automotivo de tensão

35.71.061.224



Gabarito copiador de contornos, 14 cm

35.95.014.000



Gancho magnético

35.99.038.030 - 38 mm, 30 kgf



Pegador para blocos de concreto e tijolos

35.99.450.720



Lubrificante em spray VONDER Lub PLUS

51.65.065.040 - 65 ml/40 g



Vaselina sólida industrial 1 kg

51.60.010.000



Mantas líquidas brancas

51.99.003.600 - 3,6 litros

51.99.018.000 - 18 litros



Expositor para lubrificante VONDER PLUS

80.41.003.003



Mantas líquidas asfálticas

51.99.000.360 - 3,6 litros

51.99.000.180 - 18 litros



Impermeabilizantes para parede

51.99.036.000 - 3,6 litros

51.99.180.000 - 18 litros



Óculos de segurança Boxer

70.55.510.000 - incolor
70.55.520.000 - âmbar
70.55.530.000 - verde
70.55.540.000 - fumê



Óculos de segurança ampla visão Splash incolor

70.41.060.100



Joelheira de proteção com gel

70.19.200.000



Capas impermeáveis para carro

63.64.120.405 - tamanho P
63.64.120.480 - tamanho M
63.64.120.530 - tamanho G



Capas impermeáveis para moto

63.64.122.183 - tamanho P
63.64.122.203 - tamanho M
63.64.125.232 - tamanho G



Motores 2 tempos

68.05.100.254 - MGO 254 - 25,4 cm³ (cc)
68.05.100.326 - MGO 326 - 32,6 cm³ (cc)
68.05.100.427 - MGO 427 - 42,7 cm³ (cc)



Arames farpados 350 kgf

31.74.350.250 - 250 m
31.74.350.500 - 500 m



nove54

ferramentas

MULTIMARCAS

Pás ajuntadeiras, NR 3, com cabo Y

31.22.201.002 - Quadrada
31.22.203.001 - De bico



Jogo de proteção com respirador, óculos e protetor auricular - 3M

70.99.568.463



Capacete branco, com aba frontal e catraca H-700 - 3M

70.84.700.001



Chave canhão 33 - GEDORE

30.43.062.151 - 6 mm



Trena de aço longa, caixa fechada, ST20CML - LUFKIN

38.18.020.000 - 20 m



Óleo lubrificante MS LUB 1 L - SCHULZ

51.70.021.510



Primer fundo spray uso geral, 350 ml - TEK BOND

62.78.350.191



Trenas curtas com trava, 2 m, pote com 30 unidades, L50M - LUFKIN

38.17.050.020



Consolidado mensal de lançamentos

Março 2020

MULTIMARCAS

Furadeira sem impacto 5/8" DW130V VVR
220 V~ - DEWALT

60.55.130.220



Parafusadeira/furadeira a bateria, 19G80E1, 12 V
BOSCH

60.21.198.010 - 127 V~/220 V~



Parafusadeira/furadeira com impacto a bateria,
19F83E4, 18 V - BOSCH

60.21.198.340 - 127 V~/220 V~



Sopradores térmicos - BOSCH

60.70.194.010 - 127 V~ 194DOD

60.70.194.020 - 220 V~ 194DOE



Plainas 15A9 - GHO 700 - BOSCH

60.20.159.010 - 127 V~

60.20.159.020 - 220 V~



Disco multicorte - NORTON

12.09.412.178 - 115 mm x 1,0 mm x 22,23 mm



Motor elétrico aberto, alto rendimento, 2 cv,
2 polos, IR3 trifásico, 220 V~/380 V~
NOVA MOTORES

66.80.221.020



Compressores de ar Bravo trifásicos
220 V~/380 V~ - SCHULZ

68.33.320.033 - CSL20BR/200L

68.33.240.032 - CSL40BR/250



Telas metálicas hexagonais, malha 1", com 50 m, pinteiro

- 80.68.122.100 - 22 BWG x 1,0 m
- 80.68.122.120 - 22 BWG x 1,2 m
- 80.68.122.150 - 22 BWG x 1,5 m
- 80.68.124.100 - 24 BWG x 1,0 m
- 80.68.124.120 - 24 BWG x 1,2 m
- 80.68.124.150 - 24 BWG x 1,5 m



Telas metálicas hexagonais, malha 1/2", com 50 m, viveiro

- 80.68.024.060 - 24 BWG x 0,6 m
- 80.68.024.080 - 24 BWG x 0,8 m
- 80.68.024.100 - 24 BWG x 1,0 m
- 80.68.024.120 - 24 BWG x 1,2 m
- 80.68.024.150 - 24 BWG x 1,5 m
- 80.68.026.060 - 26 BWG x 0,6 m
- 80.68.026.080 - 26 BWG x 0,8 m
- 80.68.026.100 - 26 BWG x 1,0 m
- 80.68.026.120 - 26 BWG x 1,2 m
- 80.68.026.150 - 26 BWG x 1,5 m



Telas metálicas hexagonais, malha 2", com 50 m, galinheiro

- 80.68.218.120 - 18 BWG x 1,2 m
- 80.68.218.150 - 18 BWG x 1,5 m
- 80.68.218.180 - 18 BWG x 1,8 m
- 80.68.222.150 - 22 BWG x 1,5 m
- 80.68.222.180 - 22 BWG x 1,8 m
- 80.68.223.150 - 23 BWG x 1,5 m
- 80.68.223.180 - 23 BWG x 1,8 m



Telas metálicas hexagonais, malha 3", com 50 m, mangueirão

- 80.68.316.080 - 16 BWG x 0,8 m
- 80.68.316.100 - 16 BWG x 1,0 m
- 80.68.316.120 - 16 BWG x 1,2 m
- 80.68.316.150 - 16 BWG x 1,5 m
- 80.68.316.180 - 16 BWG x 1,8 m
- 80.68.318.080 - 18 BWG x 0,8 m
- 80.68.318.150 - 18 BWG x 1,5 m



Microtrator a gasolina, 7 hp, MTV 700

68.03.007.000



Motocultivador a gasolina, 7 hp, MCV 700

68.03.000.700



Arado tipo aiveca para Microtrator MTV 700 VONDER

68.41.070.006



Colhedor de batata para Microtrator MTV 700 VONDER

68.41.070.008



Aros metálicos para pneus para Microtratores VONDER

Conjunto para MTV 700

68.41.070.003

Conjunto para MTV 1000

68.41.100.003



Enxada rotativa, jogo com 16 peças, para Motocultivador MCV 700 VONDER

68.41.007.001



Sulcador ajustável para Microtrator MTV 700 VONDER

68.41.070.007



Rodas de ferro para Microtratores VONDER

MTV 700

68.41.070.005

MTV 1000

68.41.100.005



Câmaras de ar para Microtratores VONDER

MTV 700

68.41.070.002

MTV 1000

68.41.100.002



Pneus para Microtratores VONDER

MTV 700

68.41.070.001

MTV 1000

68.41.100.001



Pneu e Câmara de ar para Motocultivador MCV 700 VONDER

Pneu

68.41.007.002

Câmara de ar

68.41.007.003



Bomba d'água para Microtrator MTV 1000 VONDER

68.41.100.006



Motor 2 tempos, 51,7 cm³ (cc), MGO 517

68.05.100.517



Motor a gasolina 7 hp MCTV 700

68.80.070.070



Escadas extensivas de alumínio

85.01.000.260 - 2 x 6 degraus

85.01.000.270 - 2 x 7 degraus

85.01.000.280 - 2 x 8 degraus

85.01.000.290 - 2 x 9 degraus



Compressores de ar

VDCSV

68.29.710.122 - 10/100, monofásico, 127 V ~/220 V~

68.29.710.133 - 10/100, trifásico, 220 V ~/380 V~

68.29.720.433 - 20/200, trifásico, 220 V ~/380 V~

VDCSL

68.29.715.222 - 15/130, monofásico, 127 V ~/220 V~

68.29.715.233 - 15/130, trifásico, 220 V ~/380 V~

68.29.720.333 - 20/200, trifásico, 220 V ~/380 V~

68.29.740.533 - 40/250, trifásico, 220 V ~/380 V~

VDCSLV

68.29.760.633 - 60/350, trifásico, 220 V ~/380 V~



Grampeadores/pinadores elétricos GPE 168

60.01.168.127 - 127 V~

60.01.168.220 - 220 V~



Lixadeiras combinadas LCV 375

60.01.375.127 - 127 V~

60.01.375.220 - 220 V~



Cinto completo para roçadeiras a gasolina

68.05.300.000



Macacos hidráulicos tipo jacaré, portáteis

68.74.200.080 - VD 1 - 0,8 tonelada (0,8 tf)

68.74.200.120 - VD 2 - 1,2 tonelada (1,2 tf)



Esquadro rápido 7"

35.50.007.000



Bombas lava rápido

BLV 20

68.64.020.000 - 2 cv bivolt

BLV 28

68.64.030.000 - 3 cv bivolt



Extensão magnética de 1/4" x 80 mm

30.39.014.080



Eixo flexível para furadeira e parafusadeira

35.99.024.110



Gancho 3,3 mm x 53 mm

28.95.134.600



Parafusos madeira

20.21.551.000 - 5,5 mm x 100 mm

20.21.557.500 - 5,5 mm x 75 mm

20.21.611.000 - 6,1 mm x 100 mm

20.21.616.500 - 6,1 mm x 65 mm



Roldanas, aço, para máquinas MIG/MAG VONDER

MM 250

68.58.250.044 - 0,6 mm - 0,8 mm

MM 405

68.99.405.218 - 0,8 mm - 1,0 mm



Parafusos madeira chipboard, cabeça chata phillips

20.22.130.120 - 3 mm x 12 mm

20.22.131.600 - 3 mm x 16 mm

20.22.132.500 - 3 mm x 25 mm

20.22.135.120 - 3,5 mm x 12 mm

20.22.135.220 - 3,5 mm x 22 mm

20.22.145.400 - 4,5 mm x 40 mm

20.22.145.500 - 4,5 mm x 50 mm

20.22.145.600 - 4,5 mm x 60 mm

20.22.150.600 - 5 mm x 60 mm

20.22.150.700 - 5 mm x 70 mm

20.22.150.500 - 5,5 mm x 50 mm

20.22.160.650 - 6 mm x 65 mm

20.22.160.900 - 6 mm x 90 mm

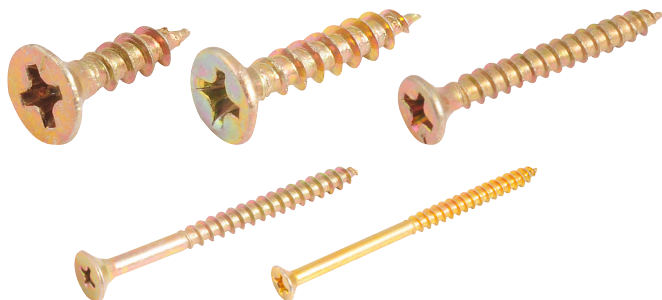

Parafusos sextavados rosca soberba

20.87.114.500 - 1/4" x 50 mm

20.87.114.600 - 1/4" x 60 mm

20.87.131.635 - 3/16" x 35 mm

20.87.131.660 - 3/16" x 60 mm

20.87.138.800 - 3/8" x 80 mm

20.87.151.660 - 5/16" x 60 mm

20.87.151.670 - 5/16" x 70 mm

20.87.151.675 - 5/4" x 75 mm

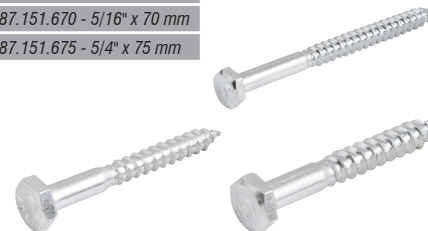

Parafusos máquina cabeça redonda, com porcas e arruelas lisas

20.36.141.000 - 1/4" x 1"

20.40.141.000 - inox, 1/4" x 1"

20.36.141.120 - 1/4" x 1.1/2"

20.40.141.120 - inox, 1/4" x 1.1/2"

20.36.145.800 - 1/4" x 5/8"

20.40.316.112 - inox, 3/16" x 1.1/2"

20.36.361.140 - 3/16" x 1.1/4"

20.40.532.100 - inox, 5/32" x 1"

20.36.532.112 - 5/32" x 1.1/2"

20.40.532.112 - inox, 5/32" x 1.1/2"

20.40.532.120 - inox, 5/32" x 1/2"



Broca com encaixe tipo SDS PLUS

13,0 mm x 380 mm x 450 mm

53.67.130.380



nove54
ferramentas

Vira-macho tipo T de 1/4" a 1/2", 150 mm

36.68.141.201



Forcado reto sem cabo, 4 dentes

31.61.100.005



Pá cortadeira quadrada, vanga, com cabo Y

31.22.201.004



Abril 2020

Furadeiras com impacto 1/2" - STANLEY

SDH600-B2

60.56.600.022 - 220 V~

SDH600-BR

60.56.600.011 - 127 V~



Disco multicorte 180 mm x 1,6 mm x 22,23 mm NORTON

12.09.700.178



Fio de nylon 2,7 mm, 2,0 kg, laranja, perfil quadrado - EKILON GRASS

33.23.200.270



Pulverizador agrícola XP 16 litros - JACTO

62.61.160.101



Luvas descartáveis, caixa com 100 peças, Pink Nitrilo - SUPERMAX

70.99.112.100 - tamanho P

70.99.112.200 - tamanho M

70.99.112.300 - tamanho G



Respirador dobrável, semifacial, sem carvão ativado, sem válvula, PFF2, VL - SAFETY

70.48.221.802



Protetor facial incolor 200 mm - UMP

70.78.001.200



Pregos com cabeça, galvanizados - GERDAU

28.69.121.200 - 12 x 12

28.69.131.500 - 13 x 15

28.69.141.800 - 14 x 18

28.69.151.500 - 15 x 15

28.69.151.800 - 15 x 18

28.69.152.100 - 15 x 21

28.69.162.100 - 16 x 21

28.69.162.400 - 16 x 24

28.69.172.100 - 17 x 21

28.69.172.700 - 17 x 27

28.69.182.700 - 18 x 27

28.69.183.000 - 18 x 30

28.69.183.600 - 18 x 36

28.69.193.600 - 19 x 36

28.69.193.900 - 19 x 39

28.69.204.200 - 20 x 42



Consolidado mensal de lançamentos

Maio 2020

vonder®

Corda para sinalização 12 mm x 150 m, trançada

80.19.012.150



Tanque para pintura, 10 litros

62.20.010.026



Compressores de ar VDCSI 7,4/30, monofásico

68.29.774.122 - 127 V ~

68.29.774.133 - 220 V ~



Jogos de soquetes sextavados de impacto, com 8 peças

30.61.008.012 - encaixe 1/2" - 10 mm a 24 mm

30.61.008.034 - encaixe 3/4" - 19 mm a 38 mm



Tesoura para fitas de aço de 12", espessura até 1,0 mm

11.55.000.012



Motosserras a gasolina

68.84.450.100 - 45,0 cm³ (cc) - MGP 450

68.84.546.100 - 54,6 cm³ (cc) - MGP 546



DWT



MULTIMARCAS

Lonas dupla face agro UV-6 - LONAX

61.60.160.100 - 6 m x 100 m - 72 kg

61.60.180.100 - 8 m x 100 m - 96 kg



Politrizes angulares 7", PAD 1300

60.05.130.127 - 127 V ~

60.05.130.230 - 220 V ~



Disco de corte 115 mm x 1,0 mm x 22,23 mm, novo BNA12 - NORTON

12.12.512.412



Máscara descartável em TNT duplo - RHINO

70.46.000.001



Para mais informações acesse nosso site: www.dismatal.com.br

Jogos de chaves de fenda/phillips mini, ponta dupla

30.70.300.000 - 3 peças
30.70.500.000 - 5 peças

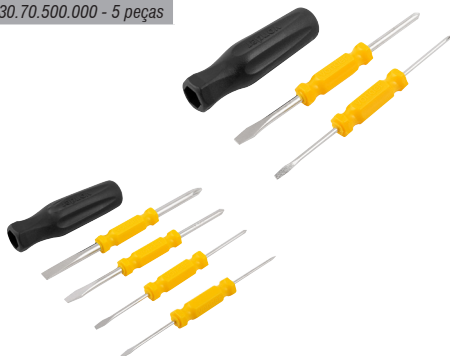

Chaves biela com furo passante, aço cromo vanádio

36.98.108.000 - 8 mm
36.98.109.000 - 9 mm
36.98.110.000 - 10 mm
36.98.111.000 - 11 mm
36.98.112.000 - 12 mm
36.98.113.000 - 13 mm
36.98.114.000 - 14 mm
36.98.115.000 - 15 mm
36.98.116.000 - 16 mm
36.98.117.000 - 17 mm
36.98.119.000 - 19 mm



Jogos de escovas manuais, com 3 peças

35.99.300.301 - aço inox
35.99.300.302 - latão
35.99.300.303 - nylon

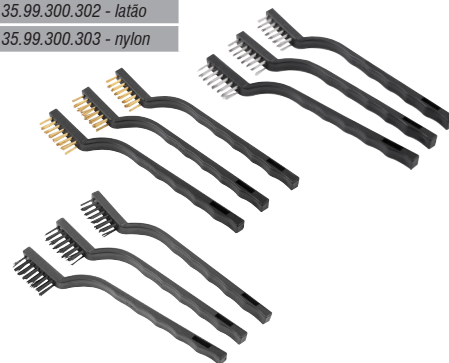

Broca de aço rápido escalonada, 4 mm a 12 mm

53.44.412.000



Grampos para o Grampeador GPE 168 VONDER, caixa com 1.000

28.98.168.208 - 8 mm
28.98.168.214 - 14 mm
28.98.168.216 - 16 mm



Lâmina para raspador, 40 mm x 60 mm

43.10.158.303



Filme stretch 150 mm x 300 m, 20 micra, rolo com aprox. 930 gramas

11.32.015.003



Corpo da Pistola Tornado para Limpeza VONDER

62.99.200.005



Válvula de acionamento (KIT) para Pistola Tornado para Limpeza VONDER

62.99.200.010



MULTIMARCAS

Lima para facão 8" - K&F

43.80.008.000



Adesivo vedante, industrial 567 com 50 g, vedante anaeróbico - LOCTITE

16.41.567.051



Óleo lubrificante multiuso 100 ml - SINGER

51.99.000.010



Lona plástica transparente cristal, 4 m x 50 m, 18 kg - LONAX

61.17.045.018



Disco de corte 350 mm x 3,2 mm x 25,4 mm, AR 302, Classic - NORTON

12.13.144.810



Chave de impacto, bateria 18 V, encaixe de 3/4", carregador bivolt, DTW1001RTJ - MAKITA

60.45.100.100



Conjunto parafusadeira/furadeira e parafusadeira com impacto, 12 V, CLX228SAX - MAKITA

60.45.228.012



Parafusadeiras/furadeiras com impacto a bateria, 12 V - MAKITA

60.45.333.042 - HP333DWYE
60.45.333.032 - HP333DWYX3



Esmerilhadeiras angulares 4.1/2", 9557 HNG MAKITA

60.45.955.741 - 127 V~
60.45.955.742 - 220 V~



Sopraadores de folhas a bateria, kit carregador, DUB362Z - MAKITA

60.45.362.010 - 127 V~
60.45.362.020 - 220 V~



Martelete perfurador e rompedor, bateria de 18 V, DHR242RFE - MAKITA

60.45.242.000



Consolidado mensal de lançamentos

Junho 2020

MULTIMARCAS

Retificadeiras M9100G - MAKITA

60.46.910.001 - 127 V~

60.46.910.002 - 220 V~



Jogo de bits/ponteiras com 28 peças, encaixe sextavado de 1/4", B-28911 - MAKITA

30.52.289.110



Jogo de bits/ponteiras com 7 peças, encaixe sextavado 1/4", D-15671 - MAKITA

30.52.156.710



Para mais informações acesse nosso site: www.dismatal.com.br

Esmerilhadeira reta 6", ERV 1050, 220 V~

60.01.105.620



Decibelímetro digital DDV 130

38.70.030.130



Luxímetro digital LDV 2000

38.70.002.000



Tacômetro digital a laser TDV 100

38.70.000.100



Termoanemômetro digital TAV 030

38.70.030.000



Lanternas recarregáveis, bateria de lítio

80.75.000.088 - 88 lúmens

80.75.000.150 - 150 lúmens



Lanterna recarregável para acampamento, bateria de lítio, LED SMD

80.75.084.350



Lanterna recarregável de emergência, bateria de lítio, LRE 500

80.75.048.500

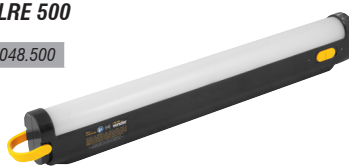

Lanterna recarregável, 80-100 lúmens, bateria de lítio, LRV 100L

80.75.080.100



Lanterna recarregável de emergência, bateria de lítio, LRE 350

80.75.052.350



Jogo de chaves canhão, 5 mm a 12 mm, 6 peças, cromo vanádio

35.73.512.000



Banqueta para mecânico

35.79.150.150



Ferro para solda com bateria de lítio, cabo USB

74.65.030.000



Ferro para solda 6 W, USB

74.65.006.001



Cortador de espuma e isopor, 6 W, USB

74.65.006.002



Jogo de bolsas infláveis multifunção, 5 peças

80.99.000.500



Arco de serra multifunção, jogo com 12 peças

35.65.012.000



Toalha de microfibra 30 cm x 40 cm, 200 g/m² (gsm), preta, jogo com 5 peças

63.64.304.000

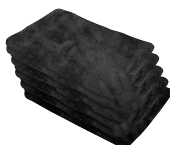

Luva de microfibra, multiuso, com dedos

63.64.025.030



Kit para limpeza automotiva, com 10 peças

63.64.010.010



Torquímetros de estalo

30.51.125.125 - 1/2", 25 N.m - 125 N.m

30.51.165.335 - 1/2", 65 N.m - 335 N.m

30.51.140.200 - 1/2", 40 N.m - 200 N.m



Chave ajustável 24" fosfatizada

35.73.024.000



Fitas adesivas para demarcação, 100 mm x 30 m

- 10.65.100.030 - Amarela
- 10.65.100.130 - Vermelha
- 10.65.100.230 - Zebra

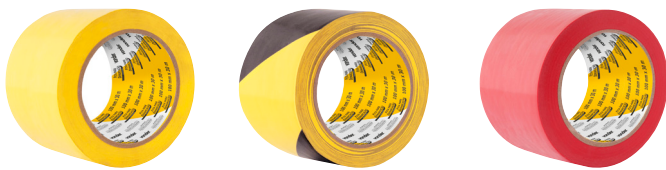

Grampos para o Grampeador GPE 168 VONDER, caixa com 1.000

- 28.98.168.210 - 10 mm
- 28.98.168.212 - 12 mm

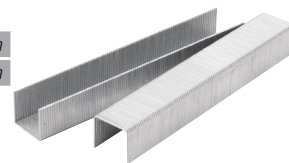

Mangueiras tipo poliuretano espiral, conector 1/4" macho, com 10 m

- 62.20.651.010 - 6,5 mm x 10 mm
- 62.20.058.010 - 5 mm x 8 mm
- 62.20.812.010 - 8 mm x 12 mm



Mangueiras cristal transparentes

- 80.12.112.250 - 1.1/2" x 2,5 mm
- 80.12.112.300 - 1.1/2" x 3,0 mm
- 80.12.114.200 - 1.1/4" x 2,0 mm
- 80.12.114.250 - 1.1/4" x 2,5 mm
- 80.12.002.300 - 2" x 3,0 mm
- 80.12.002.350 - 2" x 3,5 mm



Repuxadeiras para martelinho de ouro

- 65.10.140.620 - Pneumática
- 65.10.225.550 - Manual



Matrizes para Alicata Crimpador ACV 400 VONDER

Hexagonais

- 93.25.400.025 - 25 mm²
- 93.25.400.035 - 35 mm²
- 93.25.400.050 - 50 mm²
- 93.25.400.070 - 70 mm²
- 93.25.400.095 - 95 mm²
- 93.25.400.120 - 120 mm²
- 93.25.400.150 - 150 mm²
- 93.25.400.185 - 185 mm²
- 93.25.400.240 - 240 mm²
- 93.25.400.300 - 300 mm²
- 93.25.400.400 - 400 mm²

Redondas

- 93.25.401.016 - 16 mm²
- 93.25.401.025 - 25 mm²
- 93.25.401.035 - 35 mm²
- 93.25.401.050 - 50 mm²
- 93.25.401.070 - 70 mm²
- 93.25.401.095 - 95 mm²
- 93.25.401.120 - 120 mm²
- 93.25.401.150 - 150 mm²
- 93.25.401.185 - 185 mm²
- 93.25.401.240 - 240 mm²
- 93.25.401.300 - 300 mm²
- 93.25.401.400 - 400 mm²



Mandril de aperto rápido, 10 mm - 3/8"

- 66.70.210.038



Adaptador posição 95 para Lavadora e Aspirador LAV 1412 VONDER

- 68.98.095.141



Bateria ions de lítio de 18,0 V para parafusadeira/furadeira PFV 018 e PFV 180I VONDER e PFD 018 e PFD 180I DWT

- 93.06.018.037



Elemento filtrante para Regulador de Pressão RP 140 VONDER

- 62.49.750.007



Espumas para polimento

- 63.64.005.005 - Cone
- 63.64.004.005 - Esfera

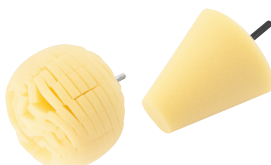

Copo para Regulador de Pressão RP 140 VONDER

- 62.49.750.009



Manômetro para Regulador de Pressão RP 140/RL 140 VONDER

- 62.49.750.001



Tocha TIG TTV 206, 3 metros, conector de 13 mm e adaptador M10 do gás

- 68.48.206.030



Guia para assentar cerâmica e porcelanato

- 35.99.200.600



Escovas de carvão para Plaina PLV 710 VONDER

- 93.20.710.110 - 127 V~
- 93.20.710.220 - 220 V~

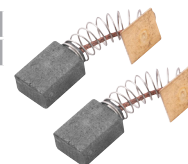

Cintas de lixa 100 mm x 915 mm, com 5 peças, para LCV 375 VONDER

- 12.37.375.060 - G 60
- 12.37.375.080 - G 80
- 12.37.375.120 - G 120



Discos de lixa 150 mm, com 10 peças, para a Lixadeira LCV 375 VONDER

- 12.58.375.080 - grão 80
- 12.58.375.120 - grão 120
- 12.58.375.180 - grão 180



Rebolo diamantado, 180 mm, turbo

- 12.66.180.000



Consolidado mensal de lançamentos

Junho 2020

nove54
ferramentas

Kit para limpeza automotiva, com 9 peças

63.64.009.954



Baldes plásticos - PLASVALE

8 Litros

33.15.508.000 - Azul

33.15.408.000 - Verde

10 Litros

33.15.510.000 - Azul

33.15.410.000 - Verde



Filtros para respirador PF5, embalagem com 100 peças - CARBOGRAFITE

70.42.500.100



Selantes de poliuretano PU 40, 380 g - CASCOLA

16.88.040.021 - Branco

16.88.040.031 - Cinza



MULTIMARCAS

Óculos de segurança maçariqueiro CARBOGRAFITE

70.41.310.001



Capacete branco, com aba frontal, ajuste fácil, H-700 - 3M

70.84.000.881



Baldes plásticos, graduados, transparentes PLASVALE

33.15.108.000 - 8 litros

33.15.111.000 - 11 litros

33.15.116.000 - 16 litros

33.15.220.000 - 20 litros



Para mais informações acesse nosso site: www.dismatal.com.br

Armários superiores modulares

- 61.14.500.110 - Canto
- 61.14.500.150 - Multiuso
- 61.14.500.140 - Para ferramentas



Bancadas modulares

- 61.14.515.010 - Móvel, 450 mm
- 61.14.515.020 - Fixa, 450 mm



Gaveta para Bancada Fixa de 450 mm, modular

- 61.14.515.040



Painel para ferramentas elétricas, modular

- 61.14.500.200



Armários modulares

- 61.14.500.180 - Multiuso, 2 portas
- 61.14.500.130 - Multiuso, 1 porta
- 61.14.500.160 - Gaveteiro misto
- 61.14.500.120 - Canto



Estante metálica monta carga 1,85 m, modular

- 61.14.500.190



Martelo unha 25 mm, antivibração

- 35.89.025.340



Chaves hexagonais (allen), embalagem unitária

- | | | |
|------------------------|-------------------------|-------------------------|
| 35.73.020.101 - 2,0 mm | 35.73.060.101 - 6,0 mm | 35.73.120.101 - 12,0 mm |
| 35.73.025.101 - 2,5 mm | 35.73.070.101 - 7,0 mm | 35.73.140.101 - 14,0 mm |
| 35.73.030.101 - 3,0 mm | 35.73.080.101 - 8,0 mm | 35.73.160.101 - 16,0 mm |
| 35.73.040.101 - 4,0 mm | 35.73.090.101 - 9,0 mm | 35.73.170.101 - 17,0 mm |
| 35.73.050.101 - 5,0 mm | 35.73.100.101 - 10,0 mm | 35.73.190.101 - 19,0 mm |



Chaves hexalobular, embalagem unitária

- | | |
|----------------------------|----------------------------|
| 35.73.110.009 - Tipo L T09 | 35.73.110.040 - Tipo L T40 |
| 35.73.110.015 - Tipo L T15 | 35.73.110.045 - Tipo L T45 |
| 35.73.110.020 - Tipo L T20 | 35.73.110.050 - Tipo L T50 |
| 35.73.110.025 - Tipo L T25 | 35.73.110.055 - Tipo L T55 |
| 35.73.110.027 - Tipo L T27 | 35.73.110.060 - Tipo L T60 |
| 35.73.110.030 - Tipo L T30 | |



Cordas multifilamento trançadas, preta e amarela

- 80.53.203.625 - 3 mm x 625 m
- 80.53.204.360 - 4 mm x 360 m
- 80.53.205.250 - 5 mm x 250 m
- 80.53.261.920 - 6 mm x 165 m
- 80.53.282.640 - 8 mm x 258 m
- 80.53.201.760 - 10 mm x 190 m
- 80.53.221.280 - 12 mm x 140 m



Cinturões de segurança tipo paraquedista

- 70.17.000.700 - CPV 700E
- 70.17.000.730 - CPV 730E
- 70.17.000.795 - CPV 795EP



Talabarte de restrição e posicionamento 251

- 70.17.000.251



Conjuntos de segurança

- 70.17.750.342 - CSV 750NE
- 70.17.750.391 - CSV 750YE



Talabarte duplo TYV 395 com ABS de energia

- 70.17.000.395



Talabarte simples TFV 343AB com ABS de energia

- 70.17.000.343



Trava-queadas para linha flexível TQV 526

70.17.000.526



Minipregador pneumático

62.56.060.100



Adesivos instantâneos

16.62.035.000 - 3,5 g
 16.62.020.000 - 20 g
 16.62.100.000 - 100 g
 16.62.075.001 - 7,5 g - blister
 16.62.075.000 - 7,5 g - caixa fechada



Matriz hexagonal 16 mm² para Alicata Crimpador ACV 400 VONDER

93.25.400.016



Tubo prolongador para Aspirador APV 2475 VONDER

68.97.247.592



Brocas/machos combinados

53.20.003.000 - M3	53.20.006.320 - N6 - 32 NC
53.20.004.000 - M4	53.20.008.320 - N8 - 32 NC
53.20.005.000 - M5	53.20.010.240 - N10 - 24 NC
53.20.006.000 - M6	53.20.014.200 - 1/4" - 20 NC
53.20.008.000 - M8	53.20.038.160 - 3/8" - 16 NC
53.20.010.000 - M10	53.20.516.180 - 5/16" - 18 NC



Jogo de brocas 3 pontas com escariador, 3 mm a 10 mm, jogo com 7 peças

35.99.003.010



Serras copo diamantadas, para esmerilhadeira

36.17.200.006 - 6 mm	36.17.200.025 - 25 mm
36.17.200.008 - 8 mm	36.17.200.032 - 32 mm
36.17.200.010 - 10 mm	36.17.200.044 - 44 mm
36.17.200.012 - 12 mm	36.17.200.051 - 51 mm
36.17.200.022 - 22 mm	36.17.200.064 - 64 mm



Arames MIG, carretel com 5 kg

74.32.010.005 - 1,0 mm
 74.32.008.050 - 0,8 mm - Sem gás



MULTIMARCAS

Cera protetora automotiva, 200 g - 2001

16.69.104.160



Massas de polir para autos, 1 kg - 2001

16.69.104.270 - nº 1
 16.69.104.280 - nº 2 premium



Capacete branco, com aba frontal e catraca H-700 - 3M

70.84.700.574



Brocas de aço rápido, DIN 338, HSS A100 - DORMER

41.60.015.001 - 1,5 mm
 41.60.020.001 - 2,0 mm



Chave canhão 10 mm 33 - GEDORE

30.43.102.003



Anemômetro digital MDA-11A - MINIPA

38.80.110.000



Alicate amperímetro digital ET-3201A - MINIPA

38.80.320.100



Respirador dobrável, sem carvão ativado, sem válvula, PFF2 - CAMPER

70.48.003.003



Massa para polir, base d'água, 1 kg - NORTON

63.75.705.108



Adesivo instantâneo, industrial Superciano, cianoacrilato, 20 g - SILOC

16.47.606.006



Consolidado mensal de lançamentos

Agosto 2020

MULTIMARCAS

Eletrificador de cerca, 30 km, PPCR, bivolt - ZEBU

78.99.223.540



Parafusadeira/furadeira com impacto a bateria, 18 V, DHP453X10 - MAKITA

60.45.453.118



Suporte Multi-Air 6", duro com parafuso - NORTON

12.95.275.006



Pilha tipo botão para eletrônicos, LR44, cartela com 2 peças - RAYOVAC

80.55.000.131



Pilha C média 10105 - RAYOVAC

80.55.101.540



Garrafa térmica em inox, 1,8 litros, Air Pot INVICTA

33.11.974.001



Nível de alumínio trapezoidal 14", com base magnética, KLTS14 - STARRETT

33.35.031.114



Discos de lixa com costado em pluma 6", A275 Multi-Air - NORTON

12.88.275.100 - Grão 1.000

12.88.275.320 - Grão 320

12.88.275.120 - Grão 1.200

12.88.275.400 - Grão 400

12.88.295.150 - Grão 1.500

12.88.275.800 - Grão 800

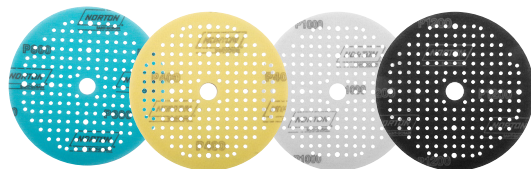

Para mais informações acesse nosso site: www.dismatal.com.br

Serras sabre SSV 1050

60.01.105.151 - 127 V~
60.01.105.152 - 220 V~



Tesoura para poda reta 8"

35.99.800.000



Perfurador a gasolina para solo, sem broca, 52 cm³ (cc) PSV 520

68.37.520.000



Correias perfil V industriais VONDER PLUS

66.97.101.600 - A-16 66.97.109.700 - A-97
66.97.101.800 - A-18 66.97.110.000 - A-100
66.97.101.900 - A-19 66.97.202.900 - B-29
66.97.102.000 - A-20 66.97.203.100 - B-31
66.97.102.100 - A-21 66.97.215.000 - B-150
66.97.108.100 - A-81 66.97.217.000 - B-170
66.97.108.300 - A-83 66.97.306.200 - C-62
66.97.109.100 - A-91 66.97.309.500 - C-95
66.97.109.300 - A-93 66.97.312.200 - C-122
66.97.109.400 - A-94



Extensores metálicos para perfurador de solo

93.26.400.000 - 400 m
93.26.800.000 - 800 m



Esticador puxador hidráulico para lataria

68.10.001.020



Macaco hidráulico tipo jacaré 5 toneladas (5,0 tf)

68.10.050.000



Lanterna recarregável, 320 lúmens, bateria de lítio, LRV 320L

80.75.320.075



Encolhedor hidráulico de molas

68.10.000.400



Bomba para teste hidrostático BTV 050

66.86.050.000



Jogo de gabarito de furação para marceneiro

35.99.600.600



Jogo de chaves de precisão, com 52 peças

35.70.052.000



Brocas espiral duplo para perfurador de solo

53.99.000.100 - 100 mm x 800 mm
53.99.000.150 - 150 mm x 800 mm
53.99.000.200 - 200 mm x 180 mm



Jogos de bits/ponteiras, encaixe sextavado de 1/4"

35.38.021.000 - 21 peças
35.38.026.000 - 26 peças
35.38.003.200 - 32 peças
35.38.061.000 - 61 peças



Lâminas para broca espiral do perfurador de solo

53.99.100.100 - 100 mm
53.99.150.150 - 150 mm
53.99.200.200 - 200 mm



Serrote

30.71.120.000 - 20" VD 20 Profissionais
30.71.101.800 - 18"
30.71.122.000 - 22" VD 22 30.71.102.000 - 20"
30.71.124.000 - 24" VD 24 30.71.102.200 - 22"
30.71.102.400 - 24"



Serrote curvo de poda 12", cabo de madeira

30.71.100.800



Serrote de ponta 12"

30.71.100.600



Máscara de escurecimento automático, tonalidade 12, caixa fechada, MSV 012

70.76.012.012



Diafragma para Regulador de Pressão RP 140 VONDER

62.49.750.002

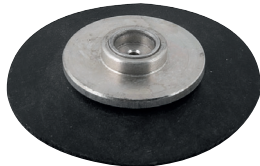

Abraçadeira grampo 6 mm, com 8 peças

28.14.060.800



Protetor de tomada, branco, com 3 peças

32.99.100.000



Bucha acabamento para cabos, branca, com 2 peças

28.97.000.000



Curvador de tubos tipo calandra

35.59.004.504



Batentes de porta completos

28.84.000.001 - Branco
28.84.000.002 - Cinza
28.84.000.003 - Cristal



Suporte para prateleira redondo, branco, com parafuso 4,0 mm x 16 mm

32.90.004.160



Limas rotativas para alumínio, com haste 6 mm

Abaulada

43.12.606.160 - 6 mm x 16 mm
43.12.608.200 - 8 mm x 20 mm
43.12.610.201 - 10 mm x 20 mm
43.12.612.251 - 12 mm x 25 mm

Esférica

43.12.600.506 - 5 mm
43.12.600.606 - 6 mm
43.12.601.006 - 10 mm



Cilíndrica

43.12.600.616 - 6 mm x 16 mm
43.12.600.820 - 8 mm x 20 mm
43.12.610.200 - 10 mm x 20 mm
43.12.612.250 - 12 mm x 25 mm

Cônica

43.12.601.020 - 10 mm x 20 mm
43.12.601.225 - 12 mm x 25 mm
43.12.601.625 - 16 mm x 25 mm

Abraçadeiras borboleta

Unitária

29.12.801.016 - 10 mm a 16 mm
29.12.801.220 - 12 mm a 20 mm
29.12.801.222 - 12 mm a 22 mm
29.12.801.625 - 16 mm a 25 mm
29.12.800.812 - 8 mm a 12 mm



Com 10 peças

29.13.801.016 - 10 mm a 16 mm
29.13.801.220 - 12 mm a 20 mm
29.13.801.222 - 12 mm a 22 mm
29.13.801.625 - 16 mm a 25 mm
29.13.800.812 - 8 mm a 12 mm



Tornos de bancada, encanador

36.94.200.020 - NR2, portátil
36.94.200.200 - NR2, fixo
36.94.200.300 - NR3, fixo
36.94.200.400 - NR4, fixo
36.94.200.600 - NR6, fixo



Conectores torção, com 8 peças

28.28.025.100 - 2,5 mm² a 10,0 mm² - amarelo
28.28.008.450 - 0,8 mm² a 4,5 mm² - azul



Conectores derivação, com 6 peças

28.27.004.600 - 4,0 mm² a 6 mm² - amarelo
28.27.075.250 - 0,75 mm² a 2,5 mm² - azul

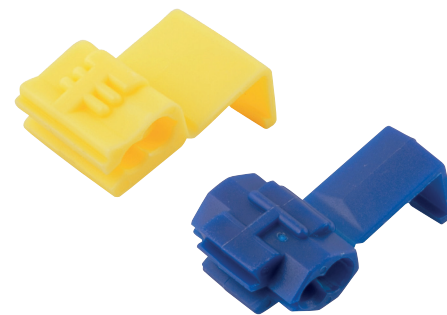

Porcas sextavadas rosca UNC

- 28.52.100.000 - 1", cartela com 2 peças
- 28.52.120.000 - 1/2", cartela com 6 peças
- 28.52.340.000 - 3/4", cartela com 2 peças
- 28.52.580.000 - 5/8", cartela com 2 peças
- 28.52.780.000 - 7/8", cartela com 2 peças



Parafusos madeira phillips

- 20.21.003.840 - 3,8 mm x 40 mm, com bucha de nylon de 6 mm
- 20.21.004.850 - 4,8 mm x 50 mm, com bucha de nylon de 8 mm
- 20.21.006.850 - 6,1 mm x 65 mm, com bucha de nylon de 10 mm

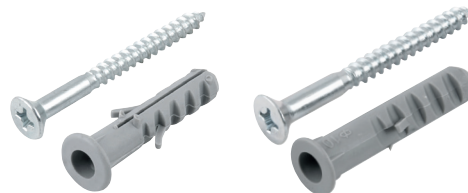

Parafusos madeira phillips, 4,2 mm x 55 mm

- 20.21.242.550 - com bucha de nylon FLY2
- 20.21.342.550 - com bucha de nylon FLY3
- 20.21.442.550 - com bucha de nylon FLY4



Grampos fixa-fio, com prego 1,8 mm x 25 mm

- 28.98.101.200 - 10/12 AWG
- 28.98.141.600 - 14/16 AWG
- 28.98.182.000 - 18/20 AWG



Grampos fixa-fio coaxial

Branco

- 28.98.004.000 - 4 mm, com prego 1,8 mm x 25 mm
- 28.98.006.000 - 6 mm, com prego 2,5 mm x 25 mm
- 28.98.007.000 - 7 mm, com prego 2,5 mm x 25 mm
- 28.98.008.000 - 8 mm, com prego 2,5 mm x 25 mm
- 28.98.010.000 - 10 mm, com prego 2,5 mm x 25 mm

Azul

- 28.98.006.100 - 6 mm, com prego 2,5 mm x 25 mm



Parafusos sextavados rosca soberba

Cartela com 4 peças

Cartela com 2 peças

- 20.87.114.300 - 1/4" x 30 mm
- 20.87.114.350 - 1/4" x 35 mm
- 20.87.114.400 - 1/4" x 40 mm
- 20.87.114.450 - 1/4" x 45 mm
- 20.87.114.550 - 1/4" x 55 mm
- 20.87.114.650 - 1/4" x 65 mm
- 20.87.114.750 - 1/4" x 75 mm

- 20.87.138.600 - 3/8" x 60 mm
- 20.87.138.700 - 3/8" x 70 mm
- 20.87.138.750 - 3/8" x 75 mm
- 20.87.138.900 - 3/8" x 90 mm
- 20.87.138.100 - 3/8" x 100 mm
- 20.87.151.635 - 5/16" x 35 mm
- 20.87.151.640 - 5/16" x 40 mm
- 20.87.151.650 - 5/16" x 50 mm
- 20.87.151.655 - 5/16" x 55 mm
- 20.87.151.665 - 5/16" x 65 mm
- 20.87.151.680 - 5/16" x 80 mm
- 20.87.151.690 - 5/16" x 90 mm



Cartela com 5 peças

- 20.87.131.630 - 3/16" x 30 mm
- 20.87.131.640 - 3/16" x 40 mm
- 20.87.131.645 - 3/16" x 45 mm
- 20.87.131.650 - 3/16" x 50 mm
- 20.87.131.670 - 3/16" x 70 mm

Conjuntos de fixação para sanitário, latonado

- 20.99.100.000 - 10 mm
- 20.99.200.000 - 12 mm

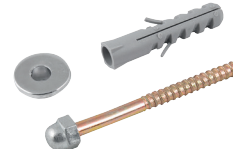

Parafusos francês com porca e arruela

Cartela com 2 conjuntos

Cartela com 4 conjuntos

- 20.44.381.000 - 3/8" x 1"
- 20.44.381.120 - 3/8" x 1.1/2"
- 20.44.382.000 - 3/8" x 2"
- 20.44.383.120 - 3/8" x 3.1/2"
- 20.44.384.000 - 3/8" x 4"
- 20.44.516.112 - 5/16" x 1.1/2"
- 20.44.516.312 - 5/16" x 3.1/2"
- 20.44.516.400 - 5/16" x 4"

- 20.44.141.000 - 1/4" x 1"
- 20.44.141.120 - 1/4" x 1.1/2"
- 20.44.143.120 - 1/4" x 3.1/2"
- 20.44.144.000 - 1/4" x 4"
- 20.44.316.100 - 3/16" x 1"
- 20.44.516.100 - 5/16" x 1"

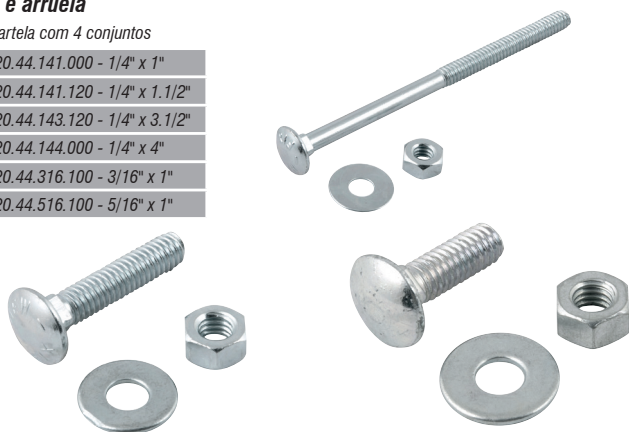

Arruelas lisas zincadas

- 28.16.000.012 - 1/2" - cartela com 6 peças
- 28.16.000.034 - 3/4" - cartela com 4 peças
- 28.16.000.058 - 5/8" - cartela com 4 peças
- 28.16.000.078 - 7/8" - cartela com 2 peças



nove54

ferramentas

MULTIMARCAS

Serrote hobby

- 30.71.101.014 - 14"
- 30.71.101.016 - 16"
- 30.71.101.020 - 20"
- 30.71.101.022 - 22"



Luva Nitriflex, tamanho G, DA-36100 - DANNY

- 70.97.361.009



Marreta oitavada com cabo em fibra, 2,0 kg, 20 F-2000 - GEDORE

- 30.49.050.148



Fita crepe, 18 mm x 50 m, Blue Tape, 2090-EP - 3M

- 10.35.209.018



Carregador de pilhas, bivolt - RAYOVAC

80.55.132.200



Inversor para solda com eletrodo e TIG, LHN 242I, 220 V~ - ESAB

68.75.002.420



Transformador para solda com eletrodo revestido, Super Bantam, 260 A Plus, 127 V~/220 V~ - ESAB

68.75.260.020



Adesivo anaeróbico para travamento de rosca, 263, 50 g, - LOCTITE

16.41.263.050



Adesivo instantâneo Super Bonder Flex Gel, 2 g, 1877391 - LOCTITE

16.49.401.202



Gaxeta para pulverizador, 7X diâmetro 50,6 mm, 1221542 - JACTO

66.10.122.154



Disco de lixa com costado em pluma 6", grão 500, A275 Multi-Air - NORTON

12.88.275.500

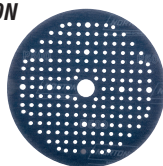

Regulador de gás blindado, sem manômetro, sem mangueira, 904/P1 - PAPAIZ

32.17.904.100



Chaves para mandril - ROEHM

66.53.124.917 - S-1, 124917
66.53.125.447 - S-2, 125447
66.53.125.524 - S-3, 125524



Ralo para pia, galvanizado, 70 mm - TELAS MM

85.55.070.000

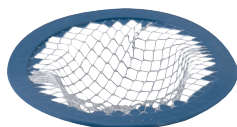

Sacador para brocas 17076 - ROHEM

66.50.017.076



Pontas rotativas - ROEHM

66.55.043.400 - CM1, 604 H 101, 043400
66.55.005.336 - CM2, 600, 005336
66.55.221.021 - CM2, 604 HMG, 221021
66.55.303.598 - CM4, 640-20, 303598
66.55.303.599 - CM5, 640-20, 303599
66.55.043.532 - CM6, 604 H 114, 043532

Para insertos intercambiáveis

66.55.061.031 - CM3 614, 061031
66.55.061.032 - CM3 614, 061032
66.55.061.038 - CM4 614, 061038
66.55.061.039 - CM5 614, 061039

Para tubos

66.55.010.613 - CM2 627, 010613
66.55.010.635 - CM3 627, 010635
66.55.044.023 - CM4 617, 044023
66.55.090.483 - CM5 617, 090483



Castanhas - ROEHM

66.32.110.160 - para placa interna de 8", 110160
66.32.110.170 - para placa externa de 8", 110170
66.32.107.937 - para placa removível de 8", 107937
66.32.108.049 - para placa removível de 10", 108049
66.32.107.504 - para placa base de 8", 107504
66.32.107.505 - para placa base 10", 107505
66.32.108.582 - para placa mole 250/3, 108582

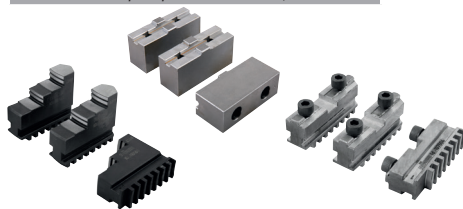

Pastilha para disco de arraste, 9,5 mm x 3,2 mm, 088209 - ROEHM

66.55.088.209

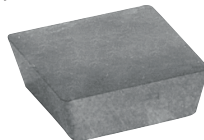

Pontas fixas de aço - ROEHM

66.55.005.381 - CM5 671, 005381
66.55.013.712 - CM4 665, 013712
66.55.013.711 - CM3 665, 013711



Mandris - ROEHM

66.55.072.811 - 6P, rosca 3/8", 0,5 mm a 6,5 mm, S1 72811
66.55.317.255 - 10S, rosca 3/8", 0,8 mm a 10,0 mm, S2 317255
66.55.322.221 - 10L, rosca 1/2", 1,0 mm a 10,0 mm, S2 1322221
66.55.322.223 - 13L, rosca 1/2", 1,5 mm a 13,0 mm, S2 1322223
66.55.322.222 - 13L, rosca 3/8", 1,5 mm a 13,0 mm, S2 1322222
66.55.154.700 - 4P, cone B10, 0,5 mm a 4,0 mm, S1 154700
66.55.245.548 - 6P, cone B12, 0,5 mm a 6,5 mm, S1 245548
66.55.072.693 - 10P, cone J2, 1,0 mm a 10,0 mm, S2 72693
66.55.072.818 - 13P, cone J6, 1,0 mm a 13,0 mm, S3 72818
66.55.072.827 - 16P, cone J3, 1,0 mm a 16,0 mm, S3 72827
66.55.072.833 - 20P, cone J3, 5,0 mm a 20,0 mm, S4 72833
66.55.072.834 - 26P, cone B24, 5,0 mm a 26,0 mm, S4 72834

Aperto rápido

66.55.871.040 - 10S, 0 - 10,0 mm, cone B12, 871040
66.55.871.009 - 10S, 0 - 10,0 mm, cone B16, 871009
66.55.871.039 - 10S, 0,5 mm - 10,0 mm, rosca 1/2", 871039
66.55.871.012 - 13M, 0 - 13,0 mm, cone B16, 871012
66.55.871.051 - 13P, 1,0 mm - 13,0 mm, cone B16, 871051
66.55.871.046 - 13S, 1,0 mm - 13,0 mm, cone B12, 871046
66.55.871.016 - 16, 3,0 mm - 16,0 mm, cone B16, 871016
66.55.871.017 - 16, 3,0 mm - 16,0 mm, cone B18, 871017
66.55.871.063 - 16S, 3,0 mm - 16,0 mm, rosca 5/8", 871063
66.55.871.032 - 8B, 0 - 8,0 mm, cone B12, 871032
66.55.871.029 - 8S, 0 - 8,0 mm, rosca 3/8", 871029



Botas de PVC, com forro

Amarela	Rosa	Vermelha
70.98.103.435 - 34/35	70.98.303.435 - 34/35	70.98.503.435 - 34/35
70.98.103.637 - 36/37	70.98.303.637 - 36/37	70.98.503.637 - 36/37
70.98.103.839 - 38/39	70.98.303.839 - 38/39	70.98.503.839 - 38/39
70.98.104.041 - 40/41	70.98.304.041 - 40/41	70.98.504.041 - 40/41

Azul	Verde
70.98.203.435 - 34/35	70.98.403.435 - 34/35
70.98.203.637 - 36/37	70.98.403.637 - 36/37
70.98.203.839 - 38/39	70.98.403.839 - 38/39
70.98.204.041 - 40/41	70.98.404.041 - 40/41



Botas infantis de PVC, com forro

Amarela	Azul	Rosa
70.98.102.021 - 20/21	70.98.202.021 - 20/21	70.98.302.021 - 20/21
70.98.102.223 - 22/23	70.98.202.223 - 22/23	70.98.302.223 - 22/23
70.98.102.425 - 24/25	70.98.202.425 - 24/25	70.98.302.425 - 24/25
70.98.102.627 - 26/27	70.98.202.627 - 26/27	70.98.302.627 - 26/27
70.98.102.829 - 28/29	70.98.202.829 - 28/29	70.98.302.829 - 28/29
70.98.103.031 - 30/31	70.98.203.031 - 30/31	70.98.303.031 - 30/31
70.98.103.233 - 32/33	70.98.203.233 - 32/33	70.98.303.233 - 32/33

Verde	Vermelha	Preta e amarela
70.98.402.021 - 20/21	70.98.502.021 - 20/21	70.98.003.435 - 34/35
70.98.402.223 - 22/23	70.98.502.223 - 22/23	
70.98.402.425 - 24/25	70.98.502.425 - 24/25	
70.98.402.627 - 26/27	70.98.502.627 - 26/27	
70.98.402.829 - 28/29	70.98.502.829 - 28/29	
70.98.403.031 - 30/31	70.98.503.031 - 30/31	
70.98.403.233 - 32/33	70.98.503.233 - 32/33	



Inversor para solda com eletrodo e TIG, RIV 206 AC/DC

68.78.206.000



Máquina de corte plasma CUT 45 PRO

68.78.045.000



Sopradores térmicos

STV 150

60.01.015.127 - 127 V~

60.01.015.230 - 220 V~

STV 200

60.01.020.127 - 127 V~

60.01.020.230 - 220 V~



Medidores de distância a laser

VD 44

38.20.000.044 - 40 metros

VD 60

38.20.060.000 - 60 metros



Sopradores térmicos digitais STV 1800

60.01.018.127 - 127 V~

60.01.018.220 - 220 V~



Bocal para Tocha TPV 66 VONDER

68.49.060.102



Roda expansiva, jogo com 5 peças

12.69.005.000



Lixas para roda expansiva, jogo com 5 peças

12.69.060.000 - grão 60

12.69.100.000 - grão 100

12.69.150.000 - grão 150

12.69.240.000 - grão 240



Tesoura para poda, bateria 36 V, carregador bivolt, TPV 360

60.01.000.360



Serrote 18" VD 18

30.71.118.000



Ganchos, com 6 peças

29.41.000.106 - 3,3 mm x 60 mm - G-6

29.41.000.108 - 4,2 mm x 70 mm - G-8

29.41.000.110 - 4,8 mm x 70 mm - G-10

29.41.106.000 - 3,3 mm x 60 mm - com bucha de nylon 6 mm, G-6

29.41.108.000 - 4,2 mm x 70 mm - com bucha de nylon 8 mm, G-8

29.41.110.000 - 4,8 mm x 70 mm - com bucha de nylon 10 mm, G-10



Escáculas com 6 peças

29.41.000.306 - 3,3 mm x 60 mm - E-6

29.41.000.308 - 4,2 mm x 70 mm - E-8

29.41.000.310 - 4,8 mm x 70 mm - E-10

Com bucha de nylon

29.41.306.000 - 3,3 mm x 60 mm - E-6

29.41.308.000 - 4,2 mm x 70 mm - E-8

29.41.310.000 - 4,8 mm x 70 mm - E-10



Buchas de nylon para fixação, com 10 peças

29.41.000.600 - 6 mm

29.41.000.800 - 8 mm

29.41.001.000 - 10 mm

29.41.001.200 - 12 mm



Pitões, com 6 peças

29.41.000.206 - 3,3 mm x 60 mm - P-6

29.41.000.208 - 4,2 mm x 70 mm - P-8

29.41.000.210 - 4,8 mm x 70 mm - P-10

Com bucha de nylon

29.41.206.000 - 3,3 mm x 60 mm - P-6

29.41.208.000 - 4,2 mm x 70 mm - P-8

29.41.210.000 - 4,8 mm x 70 mm - P-10



Chave hexalobular tipo L T10, embalagem unitária

35.73.110.010



Eletrodo para Tocha TPV 66 VONDER

68.49.060.105



Macaco telescópico para retirar caixa de câmbio

68.10.004.102



Espaçador para Tocha TPV 66 VONDER

68.49.060.101



Bico para Tocha TPV 66 VONDER

68.49.060.103



Punho completo com gatilho para Tocha TPV 66 VONDER

68.49.060.108



Suporte de arame MIG de 15 kg, para MME 160 VONDER

68.99.160.610



Anel o'ring para Tocha TPV 66 VONDER

68.49.060.106



Corpo da tocha para Tocha TPV 66 VONDER

68.49.060.107



Anel difusor para Tocha TPV 66 VONDER

68.49.060.104



Jogo de ferramentas com 110 peças

35.99.110.106



Serrote 18", hobby

30.71.101.018



DWT



MULTIMARCAS

Soprador térmico STD 200, 220 V~

60.05.020.230



Capacetes brancos, H-700 - 3M

70.84.700.575 - com aba frontal e catraca

70.87.485.098 - com ajuste, aba frontal



Fitas crepe, Blue Tape, 2090-EP - 3M

10.35.209.024 - 24 mm x 50 m

10.35.209.048 - 48 mm x 50 m



Alicates, bico curvo, 7" - BELZER

30.02.152.607 - para anéis externos - 219011B

30.02.151.607 - para anéis internos - 219009B



Adesivo instantâneo Super Bonder Original, 3 g + 1,5 g - LOCTITE

16.49.401.303



Inserto de metal duro, direita/esquerda, 6,0 mm x 3,2 mm, 088810 - ROEHM

66.55.088.810

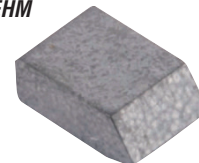

Broca de aço rápido 2,5 mm, DIN 338, HSS A100 DORMER

41.60.025.001



Soquete sextavado longo com encaixe de 1/2", 11 mm - GEDORE RED

30.41.012.100



Mandril 6P, aperto rápido, 0 - 6,0 mm, cone J1, 871024 - ROEHM

66.55.871.024



Borracha de silicone premium, neutro, 598 preta, 85 g - LOCTITE

16.47.598.085



Desengraxante spray, 400 ml, SF 7070 - LOCTITE

16.41.707.040



Regulador de gás blindado, sem manômetro, com mangueira, 904/P1 - PAPAIZ

32.17.904.102



Regulador de gás parafusado, sem manômetro, com mangueira, 906/P1 - PAPAIZ

32.17.906.102



Regulador de gás parafusado, sem manômetro, sem mangueira, 906/P1 - PAPAIZ

32.17.906.100



Verniz em spray, uso geral, 350 ml - TEKBOND

62.78.350.171



Taco lixador 125 mm x 65 mm

35.99.125.065



Lima rotativa esférica para alumínio 12 mm, com haste 6 mm

43.12.601.206



Batedor de porta, BP 100, cromado

35.99.100.111



Fixadores de portas

- 35.99.100.200 - FP 200, cromado
- 35.99.100.303 - FP 303, cromado
- 35.99.100.404 - FP 404, cromado
- 35.99.100.700 - FP 700, cromado
- 35.99.100.808 - FP 808, cromado
- 35.99.100.900 - FP 900, cromado
- 35.99.100.440 - FP 440, aço escovado



Serrote de costa 12"

30.71.100.700



Tocha para máquina de corte plasma, 60 A, 4 metros, TPV 66

68.48.060.040



Pedal de acionamento para o Inversor de Solda RIV 206 AC/DC VONDER

68.99.206.000



nove54

ferramentas

DWT

MULTIMARCAS

Jogo de bits/serras intercambiáveis com 14 peças

35.99.000.014



Sopradores térmicos

STD 150

60.05.015.127 - 127 V~

60.05.015.230 - 220 V~

STD 200

60.05.020.127 - 127 V~



Chave estrela de bater 27 mm - GEDORE

30.67.027.000



Chave de fenda 3/8" x 8" 214118BN - BELZER

30.10.214.118



Chave phillips 3/8" x 10", 217115BN - BELZER

30.12.217.115



Pino adaptador 2P para pino chato, cores sortidas, 1550 - DANEVA

78.21.001.550



Brocas de aço rápido, DIN 338, HSS A100 DORMER

41.70.564.001 - 5/64"

41.70.764.001 - 7/64"



Higienizador preventivo, tipo pulverizador, 500 ml ECOLAR

51.87.000.500



Consolidado mensal de lançamentos

Novembro 2020

MULTIMARCAS

Fitas - LORENZETTI

Isolante, preta

10.41.019.005 - 19 mm x 5 m - AG-05MAT

10.41.019.010 - 19 mm x 10 m - AG-10MAT

10.41.019.020 - 19 mm x 20 m - AG-20MAT

Autofusão, AF-5M

10.95.071.005 - 19 mm x 5 m

10.95.071.010 - 19 mm x 10 m



Extensão elétrica com 3 metros, cabo PP 2 x 0,75 mm², 2P gelo, modelo Noschock45 1717 DANEVA

78.47.001.717



Disco de corte 180 mm x 1,6 mm x 22,23 mm, novo BNA12 - NORTON

12.12.112.701



Espuma expansiva de poliuretano, 500 ml/320 g, TEK BOND

16.41.000.320



Lâmpadas de LED, bivolt - OSRAM

Bulbo

79.50.600.006 - CLA40 - 6 W, 600 lúmens

Tubo

79.50.900.009 - 9 W, 900 lúmens



Eletrificador de cerca, 35 km, bivolt, 2TT3 - ZEBU

78.99.504.410



Para mais informações acesse nosso site: www.dismatal.com.br

Aparadores de grama AGV 1000, 1.000 W

68.17.100.127 - 127 V~
68.17.100.220 - 220 V~



Máquinas para cortar grama com recolhedor, MGV 1001

68.06.101.127 - 127 V~
68.06.101.220 - 220 V~



Arame ovalado, PG 14 x 16, 1.000 metros

74.93.141.600

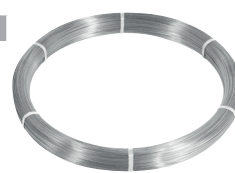

Empilhadeira semielétrica, sem bateria e carregador, 1,5 tonelada (1,5 tf), elevação 3,5 m, ESV 1500

68.57.015.010



Empilhadeira elétrica, 1,5 tonelada (1,5 tf), elevação 5,6 m, sem bateria e carregador, EEV 1500

68.57.150.010



Botas de PVC pretas com solado amarelo, cano médio, sem forro

70.75.360.000 - nº 36
70.75.370.000 - nº 37
70.75.380.000 - nº 38
70.75.390.000 - nº 39
70.75.400.000 - nº 40
70.75.410.000 - nº 41
70.75.420.000 - nº 42
70.75.430.000 - nº 43
70.75.444.500 - nº 44/45



Jogo de machos e cossinetes com 32 peças

53.99.032.000



Politriz roto-orbital 6" PRV 906, 220 V~

60.01.906.220



Alicate para abraçadeiras radiais

65.10.002.002



Alicate para abraçadeiras elásticas 9"

65.10.009.000



Catraca para soquete, encaixe 1/2", telescópica, cabeça articulada

30.59.120.001



Chaves de corrente

35.73.112.000 - 12"
35.73.115.000 - 15"
35.73.124.000 - 24"



Jogo de bits, brocas e soquetes, com 32 peças

53.53.032.000



Jogos combinados, brocas e bits

53.53.016.000 - 14 peças
53.53.019.000 - 19 peças



Bandeja móvel para mecânico

61.08.100.100



Extrator para terminal de direção, 19 mm - 22 mm

65.10.019.022



Extrator de som automotivo, jogo com 20 peças

65.10.000.020



Extrator de terminais e pivôs, conjunto com 5 peças

65.10.005.005



Encolhedor para molas de suspensão dianteira

65.10.355.120



Extrator de juntas homocinéticas

65.10.001.001

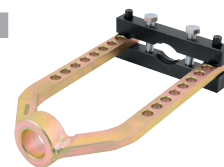

Extrator articulado para articulação esférica

65.10.205.000



Limpador de polo de bateria

65.10.201.000



Torquímetro de vareta, encaixe de 1/2", 0 - 196 N.m

30.51.000.196



Torquímetro digital, encaixe de 1/2", 20 N.m - 200 N.m

30.51.020.200



Paquímetro digital, 150 mm, função ABS, PD-ABS

35.25.150.006



Relógio comparador digital 0,001 mm RD 100

35.95.100.010



Medidor de compressão para motor, 0 - 300 PSI

65.10.000.300



Mangueira trançada multiuso, 3/8" - 9,53 mm

33.32.380.000



Mangueira cristal para gasolina 5,0 mm

80.12.050.000



Mangueira para lavar automóveis 1.000 lbf/po², 1/2" - 12,7 mm, azul

80.71.000.121



Mangueira flutuante para piscina 1.1/2" - 38,1 mm

80.93.000.112



Mangueiras de ar e água 300 lbf/po²

- 80.06.010.000 - 1" - 25,4 mm
- 80.06.011.400 - 1" - 1.1/4" - 31,8 mm
- 80.06.012.000 - 1/2" - 12,7 mm
- 80.06.014.000 - 1/4" - 6,35 mm
- 80.06.034.000 - 3/4" - 19,1 mm
- 80.06.038.000 - 3/8" - 9,53 mm
- 80.06.051.600 - 5/16" - 7,9 mm
- 80.06.058.000 - 5/8" - 15,9 mm

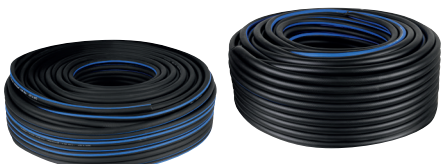

Mangueiras para óleo e graxa, PT 350 lbf/po², PVC

- 80.77.000.120 - 1/2" - 12,7 mm
- 80.77.000.140 - 1/4" - 6,35 mm
- 80.77.000.340 - 3/4" - 19,1 mm
- 80.77.000.380 - 3/8" - 9,53 mm
- 80.77.000.580 - 5/8" - 15,9 mm



Recolhedor para Máquina de Cortar Grama MGV 1001 VONDER

68.99.001.108



Carretel completo para Aparador de Grama AGV 1000 VONDER

68.99.000.115



Mangueiras para Lavadora e Aspirador LAV 1412 VONDER

- De ar 68.98.060.141
- De alta pressão 68.98.064.141



Fitas/malhas dessoldadoras

- 74.38.015.015 - 1,5 mm x 1,5 m
- 74.38.015.020 - 2 mm x 1,5 m
- 74.38.015.025 - 2,5 mm x 1,5 m
- 74.38.015.030 - 3 mm x 1,5 m



Filtro entrada de água para Lavadora e Aspirador LAV 1412 VONDER

68.98.067.141



Coletor de pó para Lavadora e Aspirador LAV 1412 VONDER

68.98.019.141



MULTIMARCAS

Baterias tracionárias - MOURA

80.55.190.000 - 24 V/190 Ah

80.55.216.000 - 24 V/216 Ah



Borrachas de silicone Superflex - LOCTITE

16.47.000.300 - neutro, 300 g

16.47.595.300 - 595, 300 g



Alicates para anéis externos - GEDORE RED

Bico reto

30.22.301.825

Bico curvo

30.22.301.826



Lubrificante em spray 300 ml Solvo Rust - LOCTITE

51.33.300.000



Mangueiras de ar e água 300 lbf/pol²

80.06.954.380 - 3/8" - 9,53 mm

80.06.954.516 - 5/16" - 7,94 mm

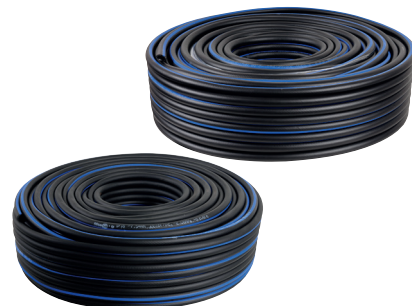

Motor elétrico aberto, alto rendimento, 5 cv, 2 polos, IR3 trifásico, 220 V~/380 V~ - NOVA MOTORES

66.80.221.050

